

# NAIS

## 30 AMP POWER RELAY WITH SPACE SAVING DESIGN

# JH-RELAYS

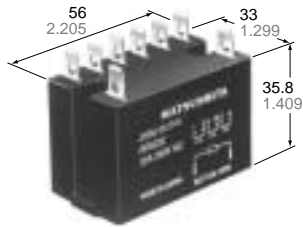

mm inch

### FEATURES

- **Many safety-oriented characteristics incorporated**  
 Contact gap: more than 3 mm .118 inch for 1 Form A and 2 Form A  
 Breakdown voltage for N.O. contact:  
 2,000 V AC between contacts  
 5,000 V AC between coil and contact  
 Molded materials: all 94 V-0
- **High dielectric strength for transient protection**  
 10,000 V surge is ms between coil and contact
- **High inrush resistance**  
 1 Form A type: 117 A (meets TV-8 requirement)  
 2 Form A type: 91 A (meets TV-6 requirement)  
**VDE, TÜV also approved**
- **Various contact arrangements**  
 1 Form A, 2 Form A, 3 Form A, 2 Form A 1 Form B

### SPECIFICATIONS

#### Contact

Arrangement	1 Form A	2 Form A	3 Form A	2 Form A 1 Form B	
Initial contact pressure	Approx. 80 g (2.82 oz)	Approx. 40 g (1.41 oz)	Approx. 30 g (1.06 oz)	N.O.: 30 g (1.06 oz); N.C.: 20 g (0.71 oz)	
Initial contact resistance, max. (By voltage drop 6 V DC 1 A)	100 mOhm				
Contact material	Silver alloy				
Rating (resistive load)	Nominal switching rating	30 A 250 V AC	20 A 250 V AC	15 A 250 V AC	N.O.: 15 A 250 V AC; N.C.: 5 A 250 V AC
	Max. switching power	7,500 VA	5,000 VA	3,750 VA	N.O.: 3,750 VA; N.C.: 1,250 VA
	Max. switching voltage	250 V AC			
	Max. switching current	30 A	20 A	15 A	N.O.: 15 A; N.C.: 5 A
Expected life (min. operations)	Mechanical (at 180 cpm)	5x10 <sup>6</sup> (10 <sup>6</sup> for latching and AC types)			
	Electrical (at nominal resistive load) (at 20 cpm)	10 <sup>5</sup>			

#### Coil

Minimum operating power	1.23 W (DC)
Nominal operating power	1.92 W (DC)

#### Characteristics

Contact arrangement	1 Form A	2 Form A	3 Form A	2 Form A 1 Form B	
Maximum operating speed	20 cpm				
Initial insulation resistance*1	Min. 100 mOhm at 500 V DC				
Initial breakdown voltage	Between open contacts	2,000 Vrms		N.O.: 2,000 Vrms; N.C.: 1,500 Vrms	
	Between contact sets	—	4,000 Vrms	3,000 Vrms	2,000 Vrms
	Between contacts and coil	5,000 Vrms		N.O.: 5,000 Vrms; N.C.: 3,000 Vrms	
Surge voltage*2	More than 10,000 V between contacts and coil				
Temperature rise (at nominal voltage)	DC: Max. 65°C; AC: Max. 85°C				
Operate time*3	Approx. 20 ms at nominal voltage (DC)				
Release time (without diode)*3	Approx. 5 ms at nominal voltage (DC)				
Shock resistance	Functional: min. 98 m/s <sup>2</sup> {10 G}; Destructive: min. 980 m/s <sup>2</sup> {100 G}			Functional: Approx. 49 m/s <sup>2</sup> {5 G} Destructive: min. 980 m/s <sup>2</sup> {100 G}	
Vibration resistance	Functional: 10 to 55Hz at 1 mm double amplitude Destructive: 10 to 55 Hz at 1.5 mm double amplitude				
Conditions for operation, transport and storage*4 (Not freezing and condensing at low temperature)	Ambient temp.	-50°C to +55°C (-58°F to +131°F)			
	Humidity	5 to 85% R.H.			
	Air pressure	86 to 106 kPa			
Molded materials used	94 V-0				
Unit weight	Approx. 90 g 3.17 oz (Approx. 115 g 4.06 oz)	Approx. 96 g 3.39 oz (Approx. 129 g 4.55 oz)	Approx. 100 g 3.53 oz (Approx. 130 g 4.59 oz) ( ) : screw type		

#### Remarks

\* Specifications will vary with foreign standards certification ratings.  
 \*1 Measurement of same location as "Initial breakdown voltage" section  
 \*2 Wave is standard shock voltage of ±1.2 x 50 μs according to JEC-212-1981  
 \*3 Excluding contact bounce time  
 \*4 Refer to 5. Conditions for operation, transport and storage mentioned in AMBIENT ENVIRONMENT (Page 61).

**TYPICAL APPLICATIONS**

Air conditioners, microwave ovens, load management equipment, copiers, process control equipment.

**ORDERING INFORMATION**



Contact arrangement	Terminals	Operating function	Coil voltage
1a: 1 Form A 2a: 2 Form A 3a: 3 Form A 2a1b: 2 Form A 1 Form B	Nil: Plug-in terminal type	Nil: Single side stable for 3 Form A, 2 Form A 1 Form B L2: 2 coil latching for 1 Form A, 2 Form A WL2: 2 coil latching for 3 Form A, 2 Form A 1 Form B	DC 6, 12, 24, 48, 110 V

- (Notes) 1. For UL/CSA recognized type, please add suffix UL/CSA.  
2. Standard Packing: Carton 20 pcs, Case 100 pcs.

**TYPES AND COIL DATA**

Single side stable (DC coils at 20°C 68°F): DC types of JH3a-W and JH2a1b-W

Nominal voltage, V DC	Pick-up voltage	Drop-out voltage	Maximum allowable voltage, at 50°C	Coil resistance (ohm)	Nominal operating power, (W)
6	Less than 80% of nominal voltage	More than 10% of nominal voltage	110% of nominal voltage	18.7	1.92
12				75	1.92
24				300	1.92
48				1,200	1.92
110				6,300	1.92

2 coil latching (DC coils only at 20°C 68°F): DC types of JH1a-L2, JH2a-L2 and JH3a-WL2

Nominal voltage, V DC	Set and reset voltage	Maximum allowable voltage, at 50°C	Coil resistance, (Ohm)		Nominal operating power, (W)	
			Coil I	Coil II	Coil I	Coil II
6	Less than 80% of nominal voltage	110% of nominal voltage	18.7	18.7	1.92	1.92
12			75	75	1.92	1.92
24			300	300	1.92	1.92
48			1,200	1,200	1.92	1.92
110			6,300	6,300	1.92	1.92

**Notes:**

1. Coil resistance varies  $\pm 10\%$  for less than 1,000 W, and  $\pm 15\%$  for more than 1,000 W. For each  $\pm 1^\circ\text{C}$  change in ambient temperature, coil resistance varies  $\pm 0.4\%$ .
2. For each  $\pm 1^\circ\text{C}$  change in ambient temperature, pick-up and drop-out voltages vary approximately  $\pm 0.4\%$ .
3. Pick-up and drop-out voltages are measured with the relay mounted as follows.
4. The coil operating current should be pure direct current in principle. When rectified alternating current is applied to the coil, the relay characteristics (pick-up, drop-out voltage) may be changed due to the ripple factor. Confirmation of the characteristics in the actual circuit is suggested.

# DIMENSIONS

## Plug-in type

### 1 Form A (JH1a-L2)

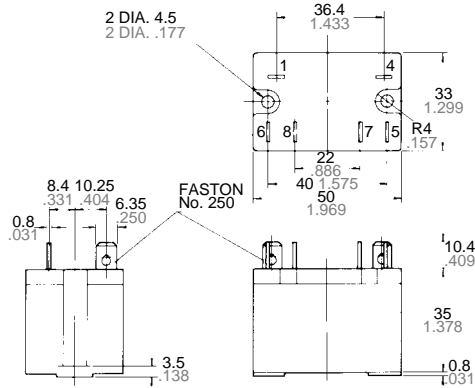

Schematic (Bottom view)

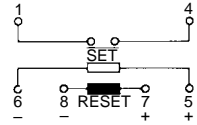

Panel cutout

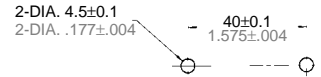

### 2 Form A (JH2a-L2)

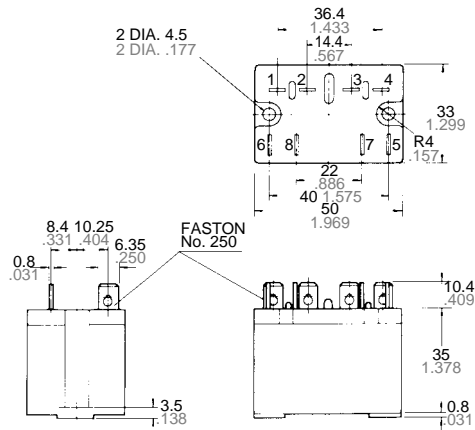

Schematic (Bottom view)

Schematic (Bottom view)

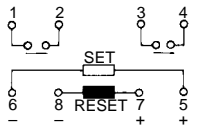

Panel cutout

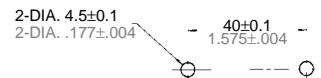

### 3 Form A (JH3a-W, JH3a-WL2)

Single side stable

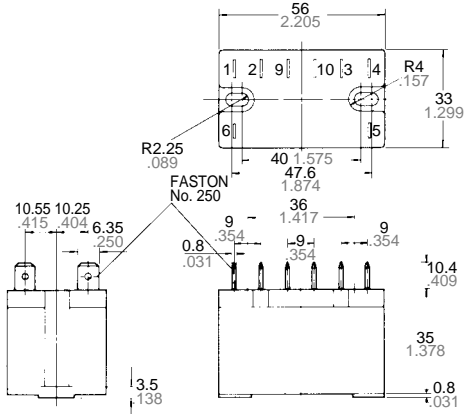

2 coil latching

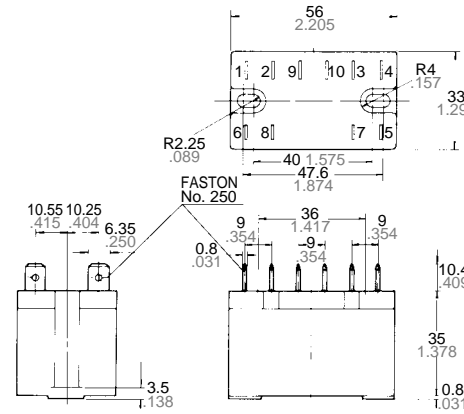

Schematic (Bottom view)

Single side stable

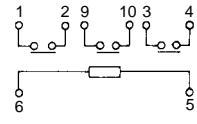

2 coil latching

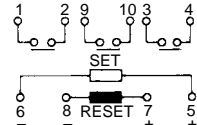

Panel cutout

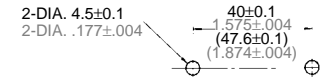

### 2 Form A 1 Form B (JH2a1b-W)

Single side stable

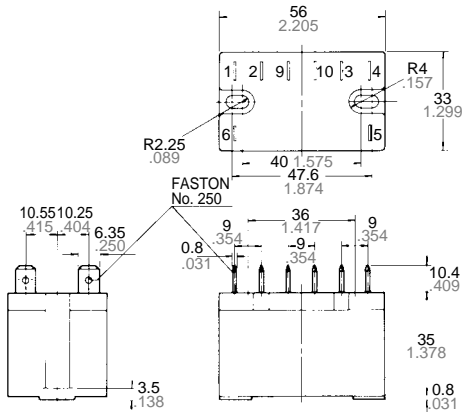

Schematic (Bottom view)

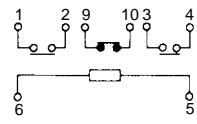

Panel cutout

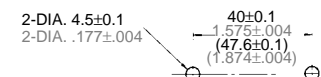

Note: 2 coil latching types of 2 Form A 1 Form B contact arrangement are not available.

REFERENCE DATA

1 Form A

1. Maximum switching power

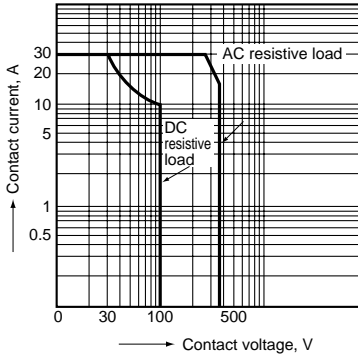

2. Life curve

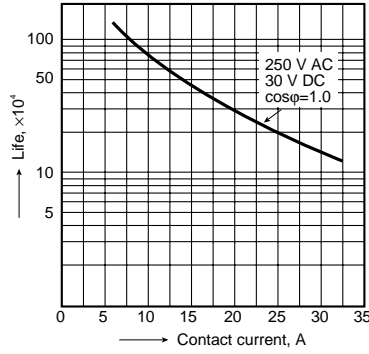

3-1 Contact temperature rise (DC type)

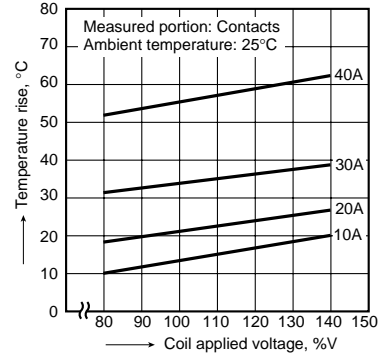

3-2 Coil temperature rise (DC type)

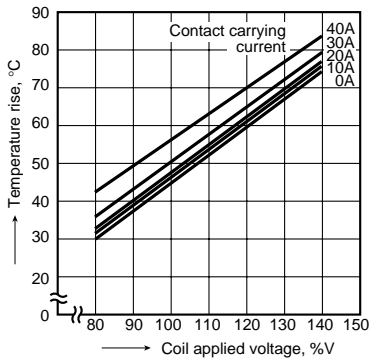

2 Form A

1. Maximum switching power

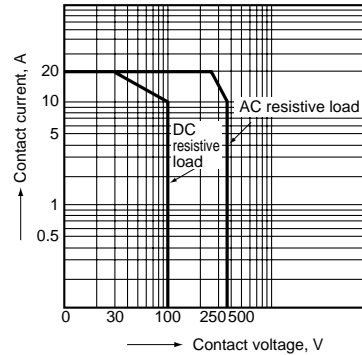

2. Life curve

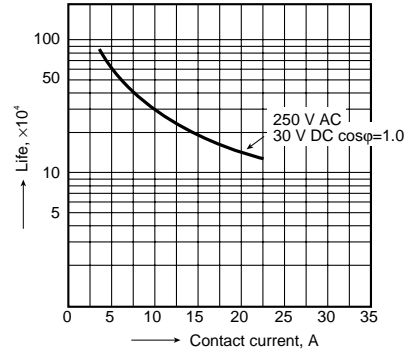

3-1 Contact temperature rise (DC type)

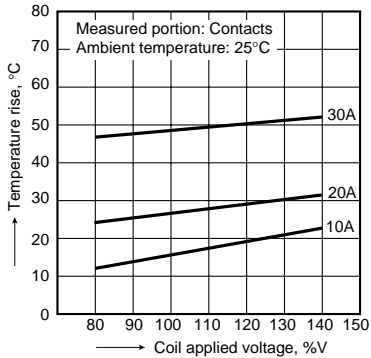

3-2 Coil temperature rise (DC type)

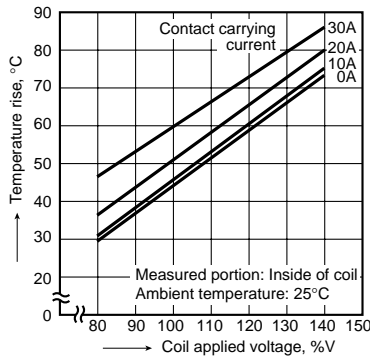

3 Form A

1. Contact temperature rise (DC type)

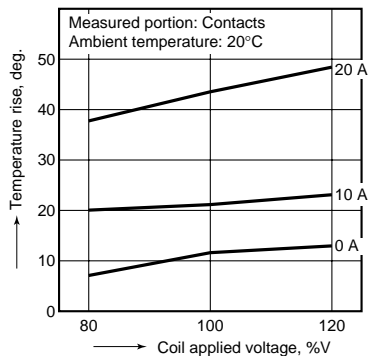

2. Coil temperature rise (DC type)

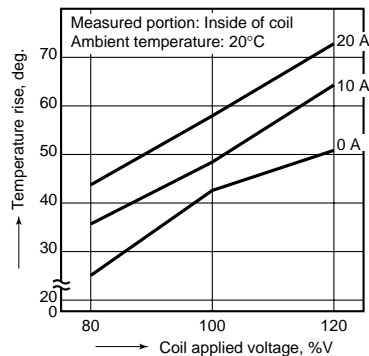

## MOUNTING METHOD

### 1. Plug-in terminal type

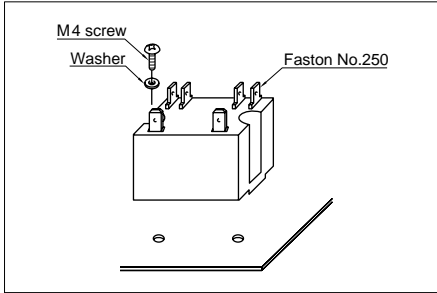

### 2. Allowable installation wiring size for terminal blocks

1a type	2.6 mm or 5.5 mm <sup>2</sup>
2a type	2.0 mm or 3.5 mm <sup>2</sup>
3a type	1.6 mm or 2 mm <sup>2</sup>

Due to the UP terminals, it is possible to either directly connect the wires or use crimped terminal

## NOTES

- The dust cover should not be removed since doing so may alter the characteristics.
- Avoid use under severe environmental conditions, such as high humidity, organic gas or in dust, oily locations and locations subjected to extremely frequent shock or vibrations.
- When mounting, use spring washers. Optimum fastening torque ranges from 5 kg to 7 kg·cm 4.5 to 6 pounds·inch.
- Firmly insert the receptacles so that there is no slack or looseness. To remove a receptacle, 2 to 4 kg of pulling strength is required. Do not remove more than one receptacle at one time. Always remove

- one receptacle at a time and pull it straight outwards.
5. Install the relay so that it lies in direction A (up-down direction). (Pick-up voltage and drop-out voltage values are those when installed in direction A.)
6. When using the AC type, the operate time due to the in-rush phase is 20 ms or more. Therefore, it is necessary for you to verify the characteristics for your actual circuit. Moreover, the release time for the NC side of the 2a1b type requires the same verification.
7. Since the JH relay latching model is polarized, be sure to follow the instructions in the wiring diagrams when wiring the +

and - coils. Mistaken wiring will lead to incorrect operation and failures. Short the negative side no. 6 and no. 8 set and reset terminals.

8. When using the push-on blocks for the screw terminal type, use crimped terminals and tighten the screw-down terminals to the torque listed below.

M4.5 screw	147 N·cm to 166.6 N·cm (15 to 17kg·cm)
M4 screw	117.6 N·cm to 137 N·cm (12 to 14 kg·cm)
M3.5 screw	78.4 N·cm to 98 N·cm (8 to 10kg·cm)

## For Cautions for Use, see Relay Technical Information (Page 48 to 76).

## JH RELAY ACCESSORIES

Terminal socket instantly attachable to DIN rail

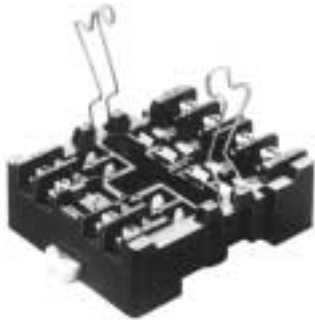

## TYPES

Part No.	Applicable relays
JH1-L2-SF	JH1a-L2
JH2-L2-SF	JH2a-L2
JH3-SF	JH3a and 2a1b
JH3-L2-SF	JH3a-WL2

## SPECIFICATIONS

Types	JH1, JH2	JH3
Maximum continuous current*	20 A 250 V AC (1a: 30 A 250 V AC)	15 A 250 V AC
Breakdown voltage	2,000 Vrms between terminals	
Insulation resistance	More than 1,000 MW between poles	
Heat resistance	150°C±3°C for 1 hour	

\* Don't insert or remove relays while in the energized condition.

## DIMENSIONS

mm inch

### 1 Form A, 2 Form A

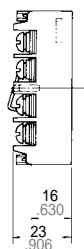
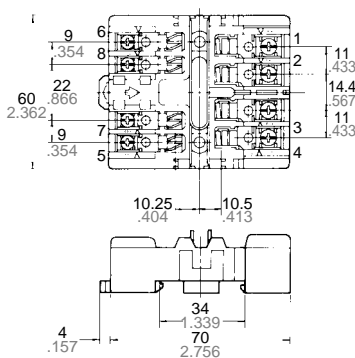

### Relay mounting diagram

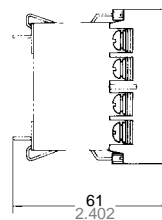

### Panel cutout

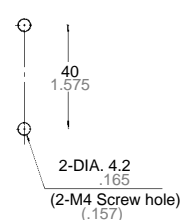

### [Notes]

The above diagrams show 2 Form A 2 coil latching type  
Terminals 2, 3 and 8 excluded for 1 Form A 2 coil latching type

Relay mounting diagram

Panel cutout

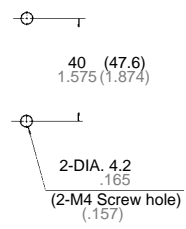
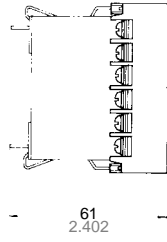
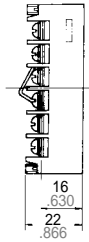
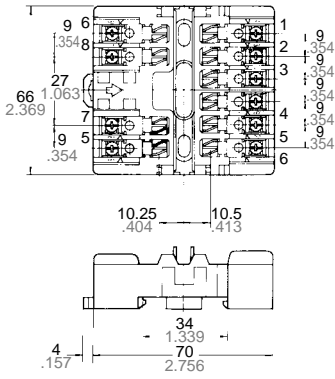

[Note] Terminals 7 and 8 excluded for single side stable type

## MOUNTING METHOD

### 1. Relay mounting

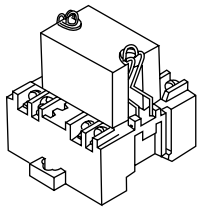

### 2. Installing to a DIN rail

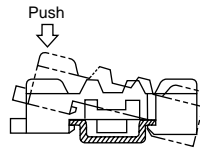

### 3. Removing from a DIN rail

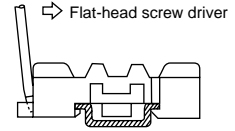

## NOTES

1. Be careful not to drop the relay. It is made of heat-hardened resin and may break.

2. Be sure to tighten the screw-down terminals firmly. Loose terminals may lead to the generation of heat.