

**TWIN POWER SILENT
AUTOMOTIVE RELAY**

CR RELAYS

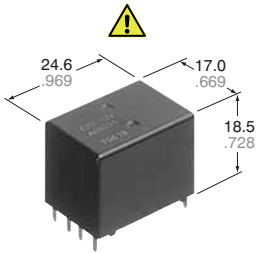

mm inch

FEATURES

- **Silent**
Noise has been reduced by approximately 20 dB, using our own silencing design.
- **Twin (1 Form C × 2)**
Forward/reverse motor control is possible with a single relay.

- **Sealed construction**
- Simple footprint enable ease of PC board layout

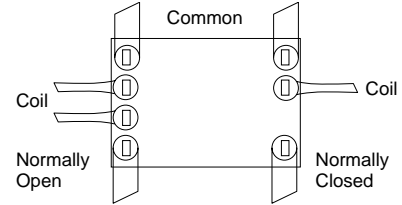

⚠ Product is discontinued.

SPECIFICATIONS

Contact

Arrangement	1 Form C × 2		
Contact material	Ag alloy (Cadmium free)		
Initial contact resistance (Initial) (By voltage drop 6 V DC 1A)	Typ. 6 mΩ (N.O.) Typ. 9 mΩ (N.C.)		
Contact voltage drop	Max. 0.2V (at 10 A)		
Rating	Nominal switching capacity	N.O.: 20 A 14 V DC N.C.: 10 A 14 V DC	
	Max. carrying current	35 A for 2 minutes, 25 A for 1 hour (12 V, at 20°C/68°F) 30 A for 2 minutes, 20 A for 1 hour (12 V, at 85°C/185°F)	
	Min. switching capacity#1	1 A 12 V DC	
Expected life (min. operations)	Mechanical (at 120 cpm)		
	Electrical	Resistive load	Min. 10 ⁵ *1
		Motor load	Min. 2×10 ⁵ *2 Min. 10 ⁵ *3

#1 This value can change due to the switching frequency, environmental conditions, and desired reliability level, therefore it is recommended to check this with the actual load.

Characteristics

Max. operating speed (at nominal switching capacity)	6 cpm	
Initial insulation resistance*4	Min. 100 MΩ (at 500 V DC)	
Initial breakdown voltage*5	Between open contacts	500 Vrms for 1 min.
	Between contacts and coil	500 Vrms for 1 min.
Operate time*6 (at nominal voltage)(at 20°C/68°F)	Max. 10 ms (initial)	
Release time*6 (at nominal voltage)(at 20°C/68°F)	Max. 10 ms (initial)	
Shock resistance	Functional*7	Min. 100 m/s ² {10G}
	Destructive*8	Min. 1,000 m/s ² {100G}
Vibration resistance	Functional*9	10 Hz to 100 Hz, Min. 44.1 m/s ² {4.5G}
	Destructive*10	10 Hz to 500 Hz, Min. 44.1 m/s ² {4.5G}

Coil

Nominal operating power	640 mW	
Conditions for operation, transport and storage*11 (Not freezing and condensing at low temperature)	Ambient temperature	-40°C to +85°C -40°F to +185°F
	Humidity	5% R.H. to 85% R.H.
Mass	Approx. 12.5g.44 oz	

Remarks

TYPICAL APPLICATIONS

- Power windows
- Auto door lock
- Electrically powered sunroof
- Electrically powered mirror, etc.

ORDERING INFORMATION

Ex. CR 2 - 12 V

Contact arrangement	Coil voltage(DC)
1 Form C × 2	12 V

Standard packing: Carton(tube package) 32pcs. Case: 800pcs.

TYPES AND COIL DATA (at 20°C 68°F)

Part No.	Nominal voltage, V DC	Pick-up voltage, V DC (Initial)*	Drop-out voltage, V DC (Initial)	Coil resistance, Ω	Nominal operating current, mA	Nominal operating power, mW	Usable voltage range, V DC
CR2-12V	12	Max. 7.2	Min. 1.0	225±10%	53.3±10%	640	10 to 16

* Other pick-up voltage types are also available. Please contact us for details.

DIMENSIONS

mm inch

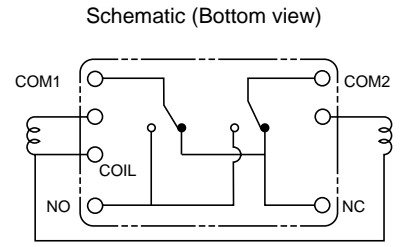
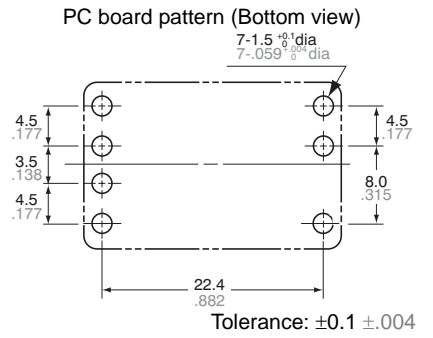
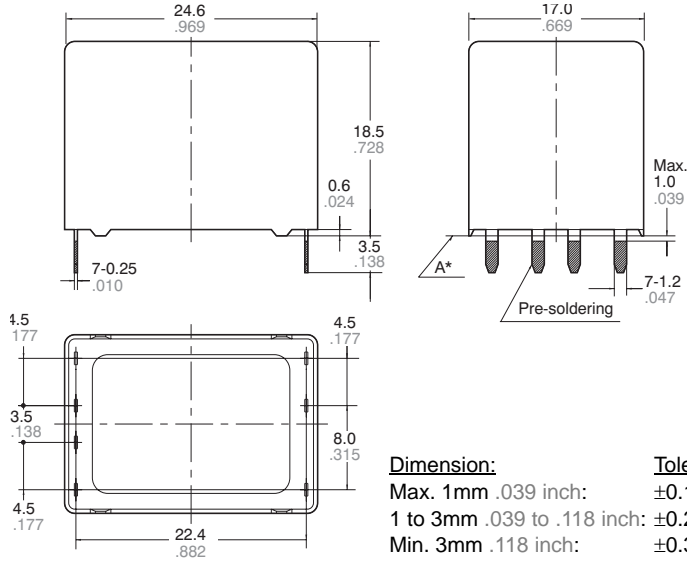

* Dimensions (thickness and width) of terminal specified in this catalog is measured before pre-soldering. Intervals between terminals is measured at A surface level.

EXAMPLE OF CIRCUIT

Forward/reverse control circuits of DC motor for power window

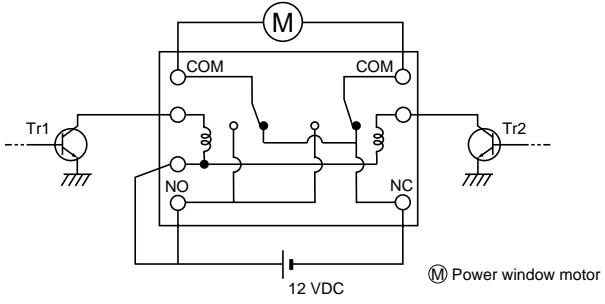

Tr1	Tr2	Motor
OFF	OFF	Stop
ON	OFF	Forward
OFF	ON	Reverse

REFERENCE DATA

1-(1). Coil temperature rise (at room temperature)

Sample: CR2-12V, 5pcs
Contact carrying current: 10A, 15A, 20A
Ambient temperature: Room temperature

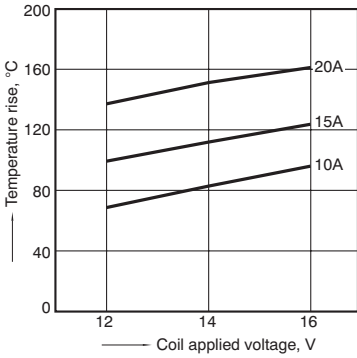

1-(2). Coil temperature rise (at 85°C 185°F)

Sample: CR2-12V, 5pcs
Contact carrying current: 10A, 15A
Ambient temperature: 85°C 185°F

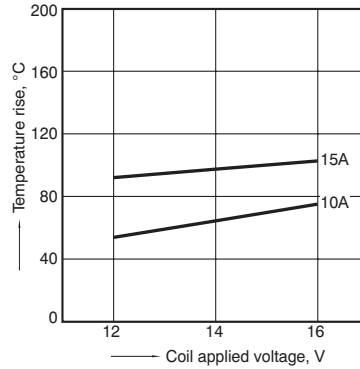

2. Max. switching capability (Resistive load, initial)

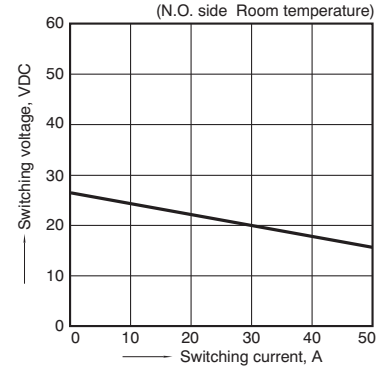

3. Ambient temperature and operating temperature range

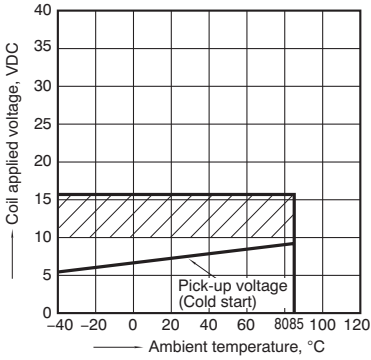

4. Ambient temperature characteristics

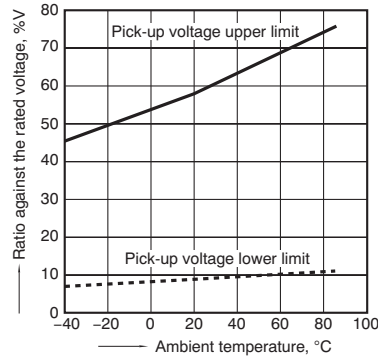

5. Distribution of pick-up and drop-out voltage
Sample: CR2-12V, 100pcs

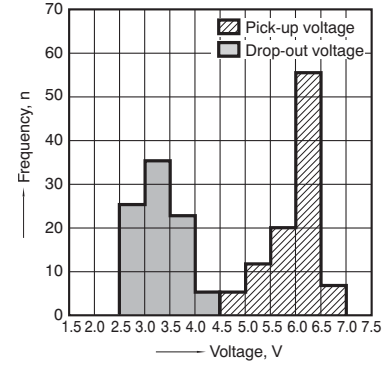

6. Distribution of operate time

Sample: CR2-12V, 100pcs

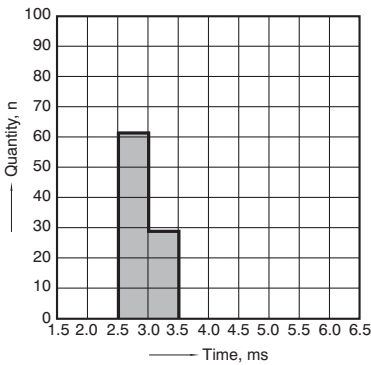

7. Distribution of release time

Sample: CR2-12V, 100pcs

* With diode

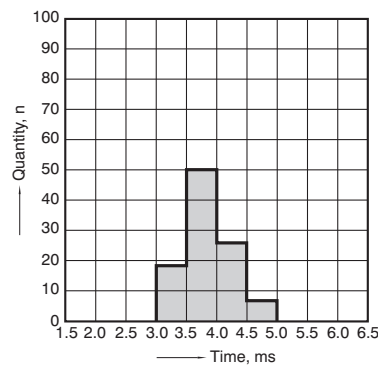

8-(1). Operation noise distribution

When operated

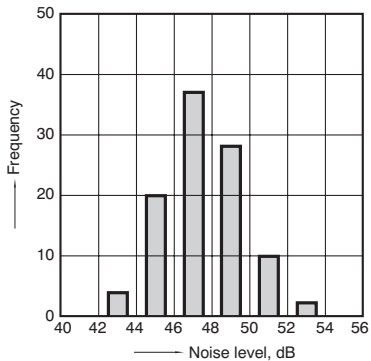

8-(2). Operation noise distribution

When released

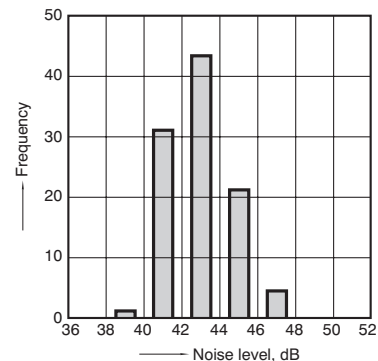

Measuring conditions

Sample: CR2-12 V, 50 pcs.
Equipment setting: "A" weighted, Fast, Max. hold
Coil voltage: 12V DC
Coil connection device: Diode
Background noise: Approx. 20dB

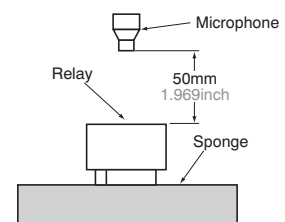

9-(1). Electrical life test (Motor free)

Sample: CR2-12V, 3pcs
 Load: Inrush current: 25A, Steady current: 6A,
 Brake current: 15A,
 power window motor actual load (free condition)
 Tested voltage: 14V DC
 Ambient temperature: Room temperature

Circuit

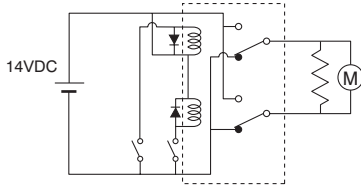

Change of pick-up and drop-out voltage

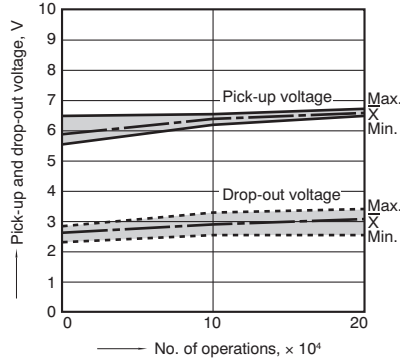

Change of contact resistance

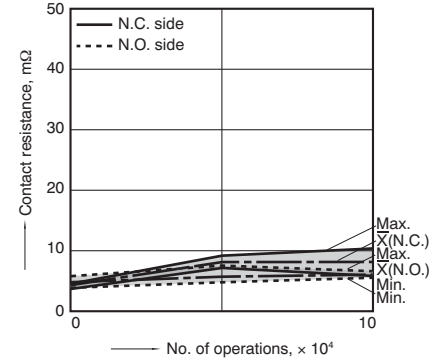

Load current waveform

Inrush current: 25A, Steady current: 6A,
 Brake current: 15A
 Tested voltage: 14V DC

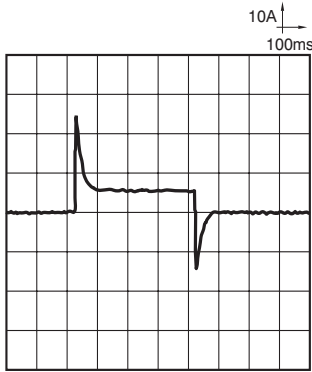

9-(2). Electrical life test (Motor lock)

Sample: CR2-12V, 3pcs
 Brake current: 22A,
 power window motor actual load (lock condition)
 Tested voltage: 14V DC
 Switching frequency: (ON:OFF = 0.5s:9.5s)
 Ambient temperature: Room temperature

Circuit

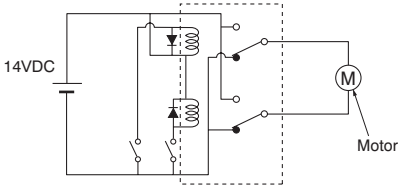

Change of pick-up and drop-out voltage

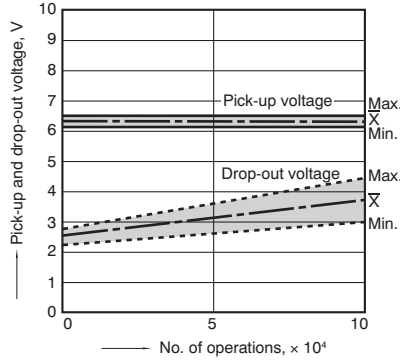

Change of contact resistance

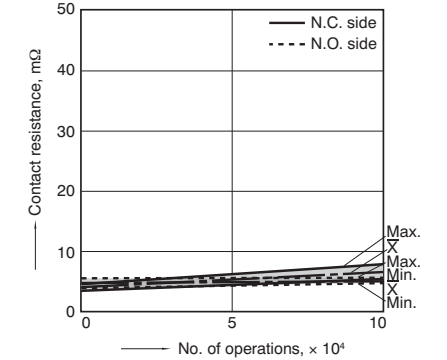

Load current waveform

Brake current: 22A
 Tested voltage: 14V DC

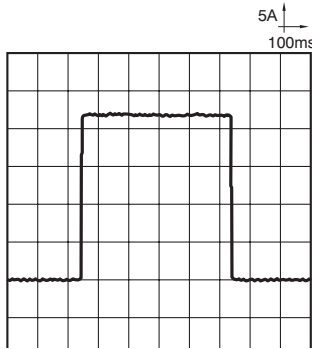

For Cautions for Use, see [Relay Technical Information](#).