

Panasonic
ideas for life

FLAT TYPE POWER RELAY

JV RELAYS

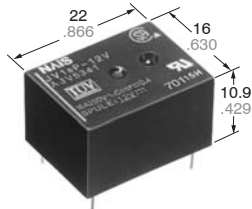

mm inch

FEATURES

- Flat type: 16 mm (length) × 22 mm (width) × 10.9 mm (height) (.630×.866×.429 inch)
- High capacity type (16A) available
- High sensitivity type (100 mW: 1 Form A) available
- TÜV also approved

SPECIFICATIONS

Contact		Standard type		High capacity type	High sensitivity type
Arrangement		1 Form A	1 Form C	1 Form A	1 Form A
Initial contact resistance, max. (By voltage drop 6 V DC 1 A)		50 mΩ			
Contact material		Silver alloy			
Rating (resistive)	Nominal switching capacity	10 A 125 V AC	10 A 125 V AC (N.O.) 6 A 125 V AC (N.C.)	16 A 125 V AC	10 A 125 V AC
	Max. switching power	1,250 VA	1,250 VA (N.O.) 750 VA (N.C.)	2,000 VA	1,250 V
	Max. switching voltage	125 V AC			
	Max. switching current	10 A	10 A (N.O.) 6 A (N.C.)	16 A	10 A
Expected life (min. ope.) Mechanical at (180 cpm)		10 ⁷			
Electrical at resistive (at 20 cpm) (at rated load)	Sealed type	10 ⁵	10 ⁵	3×10 ⁴	5×10 ⁴
	Flux-resistant type	3×10 ⁵	10 ⁵	10 ⁵	10 ⁵

Coil		1 Form A type	1 Form C type
Nominal operating power	Standard type	200 mW (up to 48 V coil type) 600 mW (100 V coil type)	400 mW (up to 48 V coil type) 600 mW (100 V coil type)
	High capacity type		—
	High sensitivity type	100 mW	—

Remarks

- * Specifications will vary with foreign standards certification ratings.
- *¹ Measurement at same location as "Initial breakdown voltage" section
- *² Detection current: 10mA
- *³ Excluding contact bounce time
- *⁴ Half-wave pulse of sine wave: 11ms, detection time: 10μs
- *⁵ Half-wave pulse of sine wave: 6ms
- *⁶ Detection time: 10μs
- *⁷ Refer to 5. Conditions for operation, transport and storage mentioned in AMBIENT ENVIRONMENT (see catalog).
- *⁸ 100V type: -40 to +60°C -40 to +140°F

Characteristics

Max. operating speed		20 cpm
Initial insulation resistance* ¹		Min. 100 MΩ (at 500 V DC)
Initial break-down voltage* ²	Between open contacts	1,000 Vrms for 1 min.
	Between contacts and coil	1,500 Vrms for 1 min.
Operate time* ³ (at nominal voltage)		Approx. 10 ms Approx. 5 ms (100 V DC coil type)
Release time (without diode)* ³ (at nominal voltage)		Approx. 4 ms
Temperature rise (at 50°C)		Max. 65°C with nominal coil voltage across coil and at nominal switching capacity
Shock resistance	Functional* ⁴	Min. 98 m/s ² {10 G}
	Destructive* ⁵	Min. 980 m/s ² {100 G}
Vibration resistance	Functional* ⁶	10 to 55 Hz at double amplitude of 1.0 mm
	Destructive	10 to 55 Hz at double amplitude of 1.6 mm
Conditions for operation, transport and storage* ⁷ (Not freezing and condensing at low temperature)	Ambient temp.	-40°C to +70°C* ⁸ -40°F to +158°F
	Humidity	5 to 85%R.H.
Unit weight		Approx. 8 g .282 oz

TYPICAL APPLICATIONS

1. Home appliances: Air conditioners, heaters, etc.
2. Automotive: Power supply for car stereo and air conditioner

ORDERING INFORMATION

Ex. JV 1a P F — S — 12V

Contact arrangement	Rating	Protective construction	Sensitivity	Coil voltage (DC)
1: 1 Form C 1a: 1 Form A	Nil: Standard type P: High capacity type*	Nil: Sealed type F: Flux-resistant type	Nil: Standard type (1 Form A: 200 mW, 1Form C: 400 mW) 100 V DC coil type: 600 mW) S: High sensitivity type* (1 Form A: 100 mW)	5, 6, 9, 12, 18, 24, 48, 100V

Notes: 1. Standard packing: Carton: 50 pcs.; Case: 1,000 pcs.
2. Coil voltage DC 48, 100 V types are not available for high sensitivity type.
UL/CSA, TÜV approved type is standard.

* Only for 1 Form A type

TYPES

Contact arrangement	Coil voltage, V DC	Part No.	
		Sealed type	Flux-resistant type
1 Form A Standard type	5	JV1a-5V	JV1aF-5V
	6	JV1a-6V	JV1aF-6V
	9	JV1a-9V	JV1aF-9V
	12	JV1a-12V	JV1aF-12V
	18	JV1a-18V	JV1aF-18V
	24	JV1a-24V	JV1aF-24V
	48	JV1a-48V	JV1aF-48V
	100	JV1a-100V	JV1aF-100V
1 Form A High capacity type	5	JV1aP-5V	JV1aPF-5V
	6	JV1aP-6V	JV1aPF-6V
	9	JV1aP-9V	JV1aPF-9V
	12	JV1aP-12V	JV1aPF-12V
	18	JV1aP-18V	JV1aPF-18V
	24	JV1aP-24V	JV1aPF-24V
	48	JV1aP-48V	JV1aPF-48V
	100	JV1aP-100V	JV1aPF-100V
1 Form A High sensitivity type	5	JV1aS-5V	JV1aFS-5V
	6	JV1aS-6V	JV1aFS-6V
	9	JV1aS-9V	JV1aFS-9V
	12	JV1aS-12V	JV1aFS-12V
	18	JV1aS-18V	JV1aFS-18V
	24	JV1aS-24V	JV1aFS-24V
1 Form C	5	JV1-5V	JV1F-5V
	6	JV1-6V	JV1F-6V
	9	JV1-9V	JV1F-9V
	12	JV1-12V	JV1F-12V
	18	JV1-18V	JV1F-18V
	24	JV1-24V	JV1F-24V
	48	JV1-48V	JV1F-48V
	100	JV1-100V	JV1F-100V

COIL DATA (at 20°C 68°F)

Part No.	Nominal voltage, V DC	Pick-up voltage, V DC (max.)	Drop-out voltage, V DC (min.)	Coil resistance, Ω ($\pm 10\%$)	Nominal operating current, mA ($\pm 10\%$)	Nominal operating power, mW	Max. allowable voltage, V DC
1 Form A (Standard type & High capacity type)	5	4.0	0.25	125	40	200	7.5
	6	4.8	0.3	180	33.3	200	9
	9	7.2	0.45	405	22.2	200	13.5
	12	9.6	0.6	720	16.7	200	18
	18	14.4	0.9	1,620	11.1	200	27
	24	19.2	1.2	2,880	8.3	200	36
	48	38.4	2.4	11,520	4.2	200	72
	100	48	3	16,600	6	600	110
1 Form A (High sensitivity type)	5	4.0	0.25	250	20	100	9
	6	4.8	0.3	360	16.7	100	10.8
	9	7.2	0.45	810	11.1	100	16.2
	12	9.6	0.6	1,440	8.3	100	21.6
	18	14.4	0.9	3,240	5.6	100	32.4
	24	19.2	1.2	5,760	4.2	100	43.2
1 Form C	5	4.0	0.25	62.5	80	400	6.5
	6	4.8	0.3	90	66.7	400	7.8
	9	7.2	0.45	202.5	44.4	400	11.7
	12	9.6	0.6	360	33.3	400	15.6
	18	14.4	0.9	810	22.2	400	23.4
	24	19.2	1.2	1,440	16.7	400	31.2
	48	38.4	2.4	5,760	8.3	400	62.4
	100	70	5	16,600	6	600	110

DIMENSIONS

1 Form A type

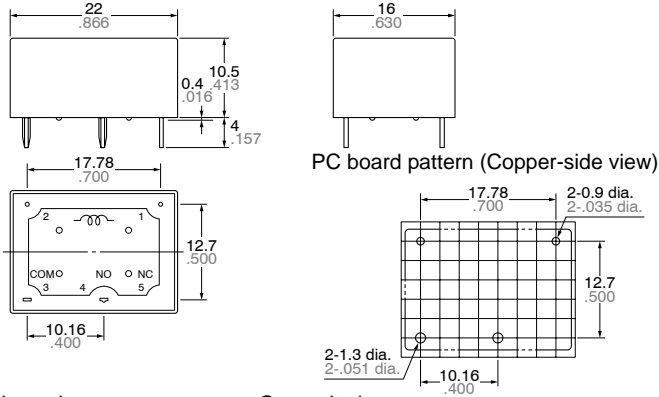

1 Form C type

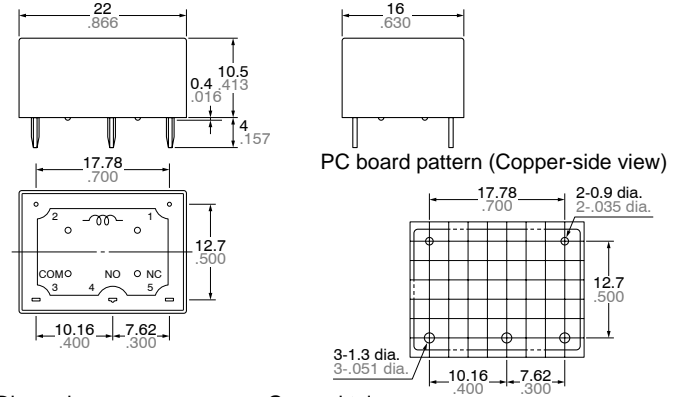

Dimension :
 Max. 1mm .039 inch
 1 to 5mm .039 to .197 inch
 Min. 5mm .197 inch

General tolerance
 $\pm 0.2 \pm .008$
 $\pm 0.3 \pm .012$
 $\pm 0.4 \pm .016$

Tolerance: $\pm 0.1 \pm .004$

Dimension :
 Max. 1mm .039 inch
 1 to 5mm .039 to .197 inch
 Min. 5mm .197 inch

General tolerance
 $\pm 0.2 \pm .008$
 $\pm 0.3 \pm .012$
 $\pm 0.4 \pm .016$

Tolerance: $\pm 0.1 \pm .004$

REFERENCE DATA

1.-(1) Maximum value for switching capacity (1 Form A type)

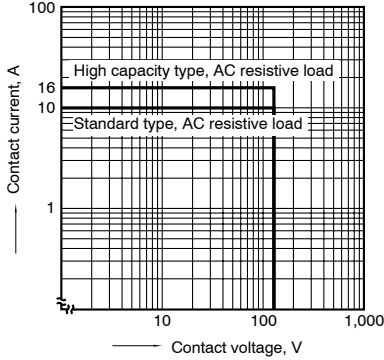

1.-(2) Maximum value for switching capacity (1 Form C type)

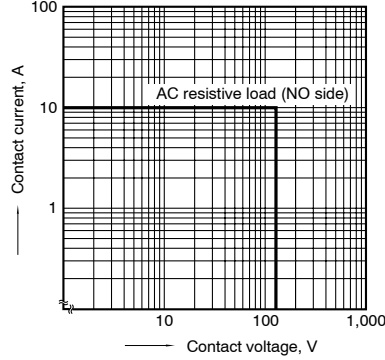

2.-(1) Operate/release time (Standard 1 Form A type)

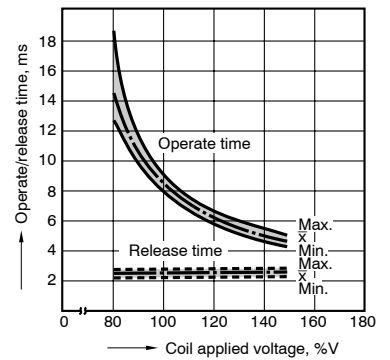

2.-(2) Operate/release time (High capacity 1 Form A type)

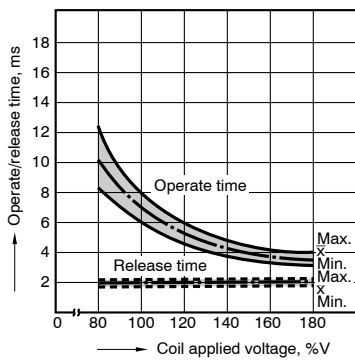

2.-(3) Operate/release time (1 Form C type)

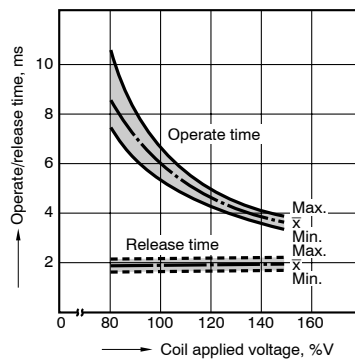

3.-(1) Coil temperature rise (1 Form A type)
 Measured portion: Inside the coil

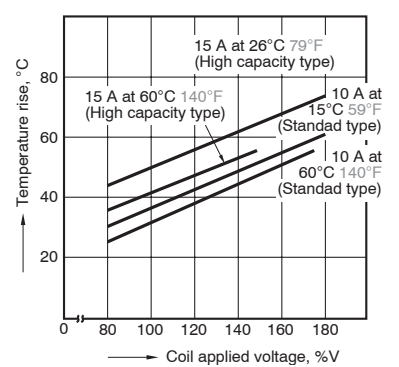

3.-(2) Coil temperature rise (1 Form C type)
 Measured portion: Inside the coil

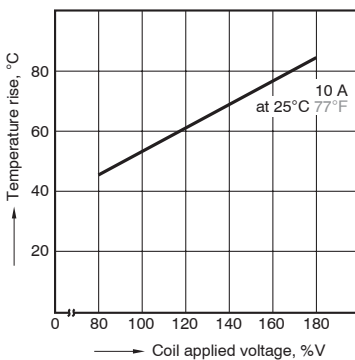

3.-(3) Coil temperature rise (High sensitivity type)
 Measured portion: Inside the coil

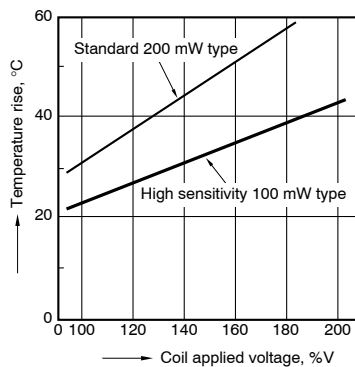

4. Life curve
 Operation frequency: 20 times/min.
 (ON/OFF = 1.5s:1.5s)
 Ambient temperature: Room temperature

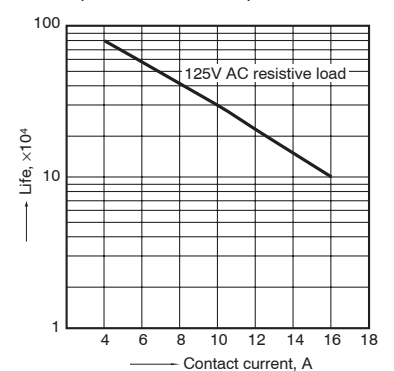

5.-(1) Ambient temperature characteristics
(Standard 10 A type, 1 Form A)

Contact current: 10 A

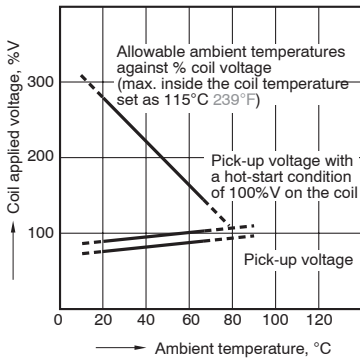

5.-(2) Ambient temperature characteristics
(High capacity 15 A type, 1 Form A)

Contact current: 0 A, 10 A, 13 A, 15 A

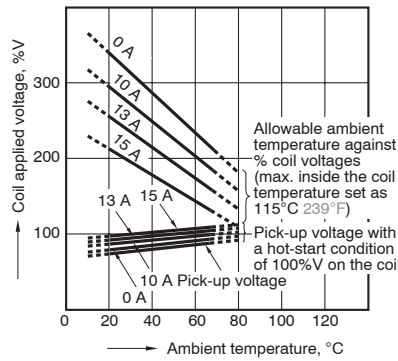

5.-(3) Ambient temperature characteristics
(1 Form C type)

Contact current: 10 A

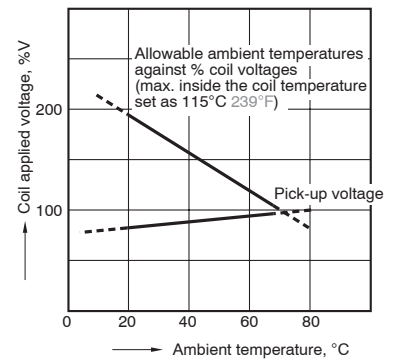

5.-(4) Ambient temperature characteristics
(High sensitivity type)

Contact current: 10 A

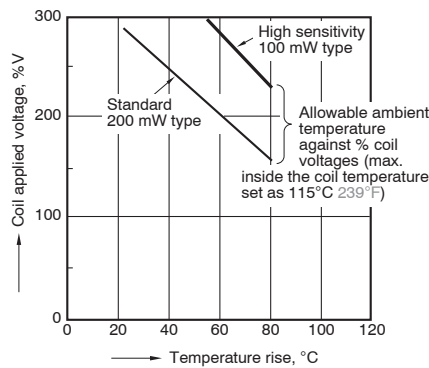

Types dedicated to a wider variety of automotive applications are available, upon receipt of order, with the following specifications:

SPECIFICATIONS

Contact		Characteristics	
Arrangement		1 Form C	
Initial contact resistance, max. (By voltage drop 6 V DC 1 A)		100 mΩ	
Contact material		Silver alloy	
Rating (resistive load)	Nominal switching capacity	10 A 125 V AC 6 A 30 V DC	
	Max. switching power	1,250 V AC 180 W	
	Max. switching voltage	125 V (AC) 30 V (DC)	
	Max. switching current	10 A (AC) 6 A (DC)	
Expected life (min. ope.)	Mechanical (at 300 cpm)	5×10 ⁶	
	Electrical (DC 12 V motor, 6 A steady current, 20 A lock current)(at rated load)	4×10 ⁴	
Coil		Max. operating speed	
Nominal voltage, V DC		20 cpm	
Nominal operating power		Initial insulation resistance	
450 mW		Min. 100 MΩ (at 500 V DC)	
Pick-up voltage, V DC (max.)		Initial break	
70% of nominal voltage		Between open contacts	
Drop-out voltage; V DC (min.)		750 Vrms for 1 min.	
5% of nominal voltage		Between contacts and coil	
Max. allowable voltage		1,500 Vrms for 1 min.	
150% of nominal voltage		Operate time (at nominal voltage)	
		Approx. 5 ms	
		Release time (at nominal voltage)	
		Approx. 4 ms	
		Temperature rise (max.) (at nominal voltage)(at 50°C)	
		65°C with nominal coil voltage and at maximum allowable contact current	
		Shock resistance	
		Functional	
		Min. 196 m/s ² {20 G}	
		Destructive	
		Min. 980 m/s ² {100 G}	
		Vibration resistance	
		Functional	
		10 to 55 Hz at double amplitude of 1.6 mm	
		Destructive	
		10 to 55 Hz at double amplitude of 2 mm	
		Conditions for operation, transport and storage	
		Ambient temp.	
		-40°C to +70°C -40°F to +158°F	
		Humidity	
		5 to 85%R.H.	
		Unit weight	
		Approx. 8 g .282 oz	

For Cautions for Use, see Relay Technical Information (see catalog).