

**Panasonic**  
ideas for life

**MODERN STEPPER RELAY  
USING ELECTRONIC  
SWITCHING CIRCUIT**

**VS MODULE**

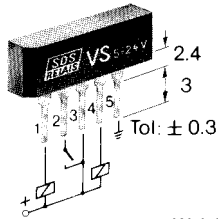

Weight 0.7 g  
Pin Grid 2.54  
PCB hole dia 0.6

Dimensions 18.5 x 3.3 x 6.3

- High reliability and efficiency
- Low power requirement
- Short switching times
- Economic and spacesaving
- Universal application in stepper devices or counters
- Suitable for most common washing methods except ultrasonic cleaning

Relay connection – In contrast to connecting between pins 2 and 4 connecting contact K across pins 2 and 3 of the new VS monolithic module (as shown above) ensures reliable switching even with bouncing signals. On the earlier design of thick film VS module, the contact K had to be connected between pins 2 and 4 in all cases.

Traditional stepper relays maintain their latched position mechanically, but by using the VS switching principle with polarised 2 coil relays this is not required. The already well known operating characteristics of polarised relays remain unchanged. Switching of the relay using the VS module is achieved as shown in the above diagram. A relay contact is required for the internal circuitry and is thus not available for other switching circuits. This applies to changeover contacts.

The VS5-24V Electronic module is suitable for 4V to 30V coil voltage. It withstands temperatures between -55°C to +125°C and can be operated between -20°C and +80°C.

**Operation**

A logic level of 3.6 V for the logic circuitry is obtained as shown in the block diagram, from the voltage regulator. A relay contact K is connected between pin 2 and the positive terminal 3 of the power supply. On receiving a signal from the output of the schmitt trigger the pulse generator gives a 10 micro second impulse which changes the logical state at input 1 of both AND gates to „high“. The logical state of input 2 of gate A is „low“ since the relay contact K is open: input 2 of gate B is „high“ due to the inverter I depending on the input signals, the output of the AND gate B is driven „high“ and the flip flop F/F is set switching the output „Q“ high and turning on the transistor Ts.

The relay is then latched by coil L2 and the contact K closes.

With contact K now closed and the voltage U applied, the logical state of input 2 goes „high“ so that both inputs 2 of the AND gates change state from their previous condition.

(Input 2 of AND gate A goes high and input 2 of AND gate B goes „low“). Simultaneously a 10 microsecond impulse from the pulse generator is fed to the input 1 of both AND gates consequently the output of gate A goes „high“ and the output of gate B goes „low“. The F/F is reset, the transistor Tr is driven on by output „Q“, and the relay coil L1 is energized, opening the contact K.

The maximum output current of the VS module is 100 mA. Thus depending on coil resistance several relays can be controlled by a single VS module.

The more important characteristics of relay types which can be combined with the VS module are described on the rear of this datasheet.

**Block diagram of VS module (For connection diagram see over)**

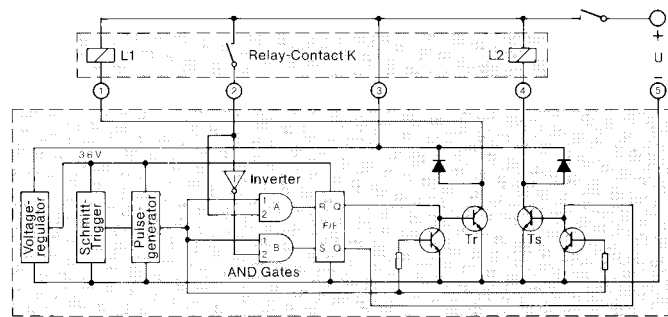

**Stepping devices**

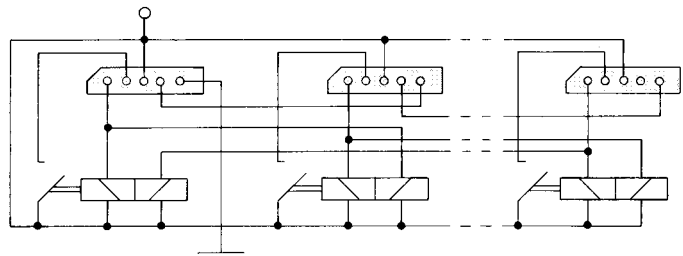

**Binary counters, Frequency dividers**

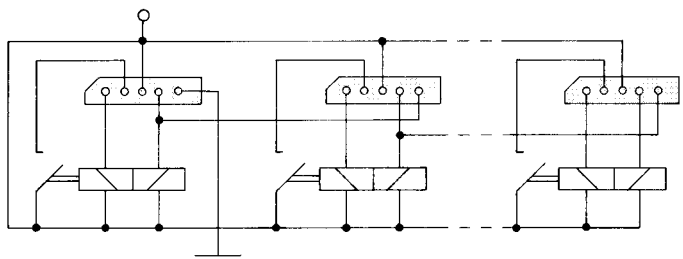

**Counters**

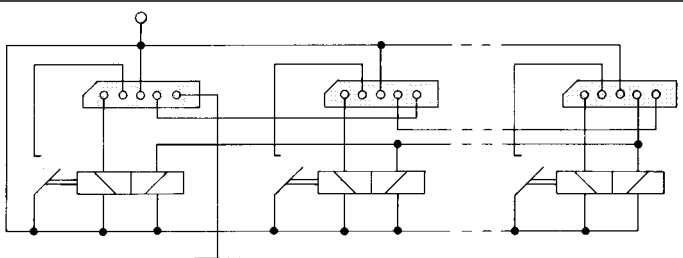

**Characteristics** Further relay data is available on the appropriate data sheets.

\* Depending on the switching configuration, the given contact arrangement can vary; a and b contacts can be wired as change-over contacts.  
 Contact configuration:  
 a = normally open  
 b = normally closed  
 c = change over

Type	RG	TQ	DF	DX
Dimensions: (l x b x h)	mm 25 x 23 x 9.9	14 x 9 x 5	16 x 9.9 x 7	20 x 12 x 6
No. of available contacts *	1c	1c	1c	1c
Max. make current	A -	5	-	3
Max. continuous current	A 1	2	1	2
Max. break current	A 1	1	1	1
Max. break voltage	V 24	125	125	220
Max. break power	W/VA 24	30/62.5	30/30	30/50
Nom. power consumption	W 0.52	0.32	0.32	0.4
Test voltage: cont./cont./coil	V <sub>rms</sub> 1000/2000	750/1000	500/1000	500/500
Max. switching frequency	Hz 50	100	100	200

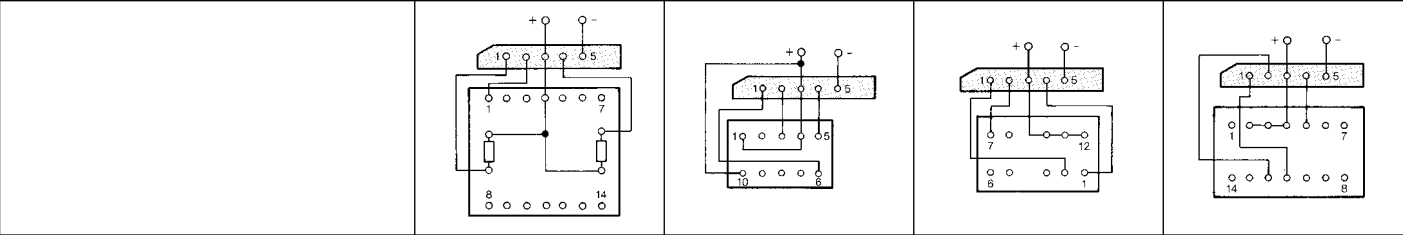

\* Depending on the switching configuration, the given contact arrangement can vary; a and b contacts can be wired as change-over contacts.  
 Contact configuration:  
 a = normally open  
 b = normally closed  
 c = change over

Type	DS	DSP	S	ST
Dimensions: (l x b x h)	mm 20/35.2 x 9.9 x 9.3	20.2 x 11 x 10.5	28.4 x 12.5 x 10.2	31 x 14 x 11
No. of available contacts *	1c/3c	1a	2a1b/3a/1a2b	1a/1b
Max. make current	A 8	18   26	20	50/35
Max. continuous current	A 3	5   5	5	8
Max. break current	A 2	5   5	5	8
Max. break voltage	V 250	380	250	250
Max. break power	W/VA 60/125	150/1250	100/1000	150/2000
Nom. power consumption	W 0.48	0.42	0.32	0.345
Test voltage: cont./cont./coil	V <sub>rms</sub> 1000/1500	1000/3000	750/1500	1200/3750
Max. switching frequency	Hz 100	50	50	50

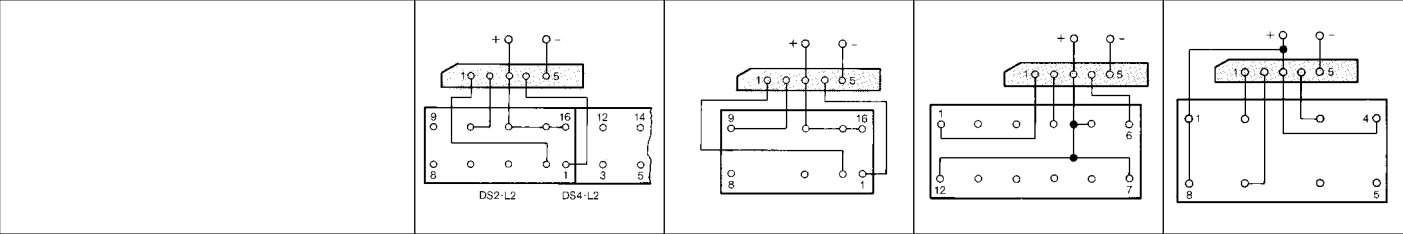

\* Depending on the switching configuration, the given contact arrangement can vary; a and b contacts can be wired as change-over contacts.  
 Contact configuration:  
 a = normally open  
 b = normally closed  
 c = change over

Type	DK	SP	
Dimensions: (l x b x h)	mm 20 x 12.5 x 9.7	50x25.6x20.5	50x36.8x20.5
No. of available contacts *	1a	1c	3c
Max. make current	A -	70	50
Max. continuous current	A 8	16	10
Max. break current	A 8	16	10
Max. break voltage	V 380	250	
Max. break power	W/VA 240/2000	300/4000	300/2500
Nom. power consumption	W 0.32	0.42	
Test voltage: cont./cont./coil	V <sub>rms</sub> 1000/4000	1500/3000	
Max. switching frequency	Hz 50	10	

