

# NAIS

## COMPACT "SLIM" AND "FLAT" 16A RELAYS WITH HIGH HEAT RESISTANCE

# JL-RELAYS

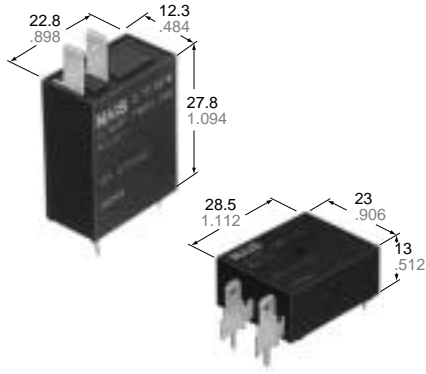

mm inch

### FEATURES

• "Slim" and "Flat" types

Use the slim type when PCB real estate is limited, and the flat type when headroom is limited.

• High switching capacity

AC switching capacity is a high 16 A 277 V, and the #187 tab terminals allow quick connection.

• Operates at high temperatures

The relays can be used at ambient temperatures of up to 85°C 185°F. This satisfies UL Insulation Class B (consult with our sales representative)

### SPECIFICATIONS

#### Contact

		Slim type	Flat type
Arrangement		1 Form A	
Initial contact resistance, max. (By voltage drop 6 V DC 1A)		100 mOhm	
Contact material		Silver alloy	
Rating (resistive load)	Nominal switching capacity	16 A 277 V AC	
	Max. switching power	4,432 VA	
	Max. switching voltage	277 VAC	
	Max. switching current	16 A	
Expected life (min. operations)	Mechanical (at 180 cpm)	2x10 <sup>6</sup>	
	Electrical (at 20 cpm) (Resistive load)	10 <sup>5</sup>	

#### Coil

Nominal operating power	500 mW
-------------------------	--------

#### Remarks

- \* Specifications will vary with foreign standards certification ratings.
- \*1 Detection current: 10mA
- \*2 Wave is standard shock voltage of ±1.2 x 50µs according to JEC-212-1981
- \*3 Excluding contact bounce time
- \*4 Half-wave pulse of sine wave: 11ms; detection time: 10µs
- \*5 Half-wave pulse of sine wave: 6ms
- \*6 Detection time: 10µs
- \*7 Refer to 5. Conditions for operation, transport and storage mentioned in AMBIENT ENVIRONMENT (Page 61).

#### Characteristics

		Slim type	Flat type
Max. operating speed (at rated load)		20 cpm	
Initial insulation resistance		Min. 100 MOhm (at 500 V DC)	
Initial breakdown voltage*1	Between open contacts	1,000 Vrms for 1 min.	
	Between contacts and coil	5,000 Vrms for 1 min.	
Surge voltage between contact and coil*2		Min. 10,000 V	
Operate time*3 (at nominal voltage)(at 20°C)		Approx. 7 ms	
Release time (without diode)*3 (at nominal voltage)(at 20°C)		Approx. 2 ms	
Temperature rise (at nominal voltage)		Max. 55°C (resistance method, contact current 16 A, rated coil voltage, 20°C)	
Shock resistance	Functional*4	Min. 98 m/s <sup>2</sup> {10 G}	
	Destructive*5	Min. 980 m/s <sup>2</sup> {100 G}	
Vibration resistance	Functional*6	10 to 55 Hz at double amplitude of 1.0 mm	
	Destructive	10 to 55 Hz at double amplitude of 2.0 mm	
Conditions for operation, transport and storage*7 (Not freezing and condensing at low temperature)	Ambient temp.	-40°C to +85°C -40°F to +185°F	
	Humidity	5 to 85% R.H.	
Unit weight		Approx. 17 g .60 oz	Approx. 18 g .63 oz

### TYPICAL APPLICATIONS ORDERING INFORMATION

Microwave ovens, rice cookers, irons, fan heaters and hot water units.

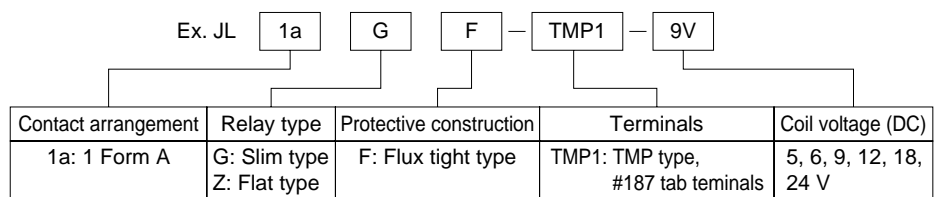

Note: Standard packing:  
 <Slim type> Carton: 100pcs. Case: 500pcs.  
 <Flat type> Carton: 50pcs. Case: 500pcs.

## TYPES AND COIL DATA (at 20°C 68°F)

Part No.		Nominal voltage, V DC	Pick-up voltage, V DC (max.)	Drop-out voltage, V DC (min.)	Normal operating current, mA (±10%)	Coil resistance, Ohm (±10%)	Normal operating power, mW	Max. allowable voltage, (at 60°C 140°F)
Slim type	Flat type							
JL1aGF-TMP1-5V	JL1aZF-TMP1-5V	5	3.5	0.25	100	50	500	130% of nominal voltage (100% of nominal voltage at 85°C 185°F)
JL1aGF-TMP1-6V	JL1aZF-TMP1-6V	6	4.2	0.3	83.3	72		
JL1aGF-TMP1-9V	JL1aZF-TMP1-9V	9	6.3	0.45	55.6	162		
JL1aGF-TMP1-12V	JL1aZF-TMP1-12V	12	8.4	0.6	41.7	288		
JL1aGF-TMP1-18V	JL1aZF-TMP1-18V	18	12.6	0.9	27.8	648		
JL1aGF-TMP1-24V	JL1aZF-TMP1-24V	24	16.8	1.2	20.8	1,152		

## REFERENCE DATA

### 1. Operate/release time

Sample: JL1aZF-TMP1-12V, 20 pcs.  
Ambient temperature: 25°C 77°F

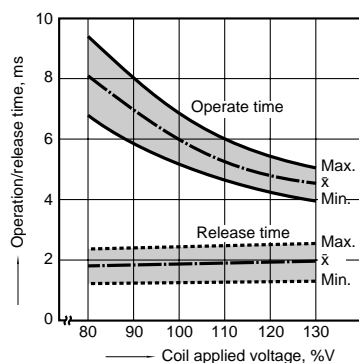

### 2. Coil temperature rise

Sample: JL1aGF-TMP1-12V, 5 pcs.  
Point measured: inside the coil  
Ambient temperature: 26°C 79°F

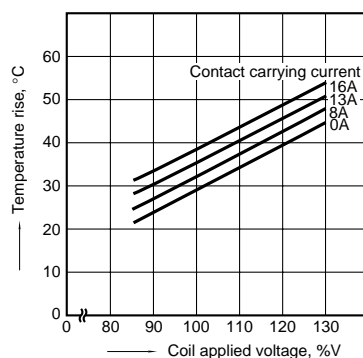

### 3. Ambient temperature characteristics

(Contact carrying current: 16 A)  
Sample: JL1aGF-TMP1-12V, 6 pcs.

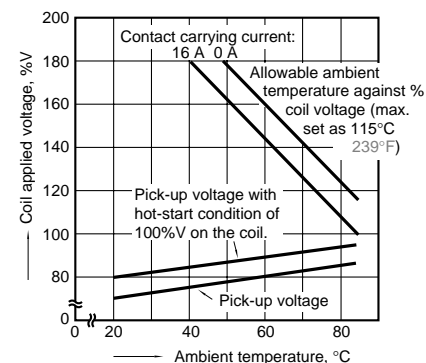

### 4. Life curve

Operation frequency: 20 times/min.  
(ON/OFF = 1.5s:1.5s)  
Ambient temperature: Room temperature

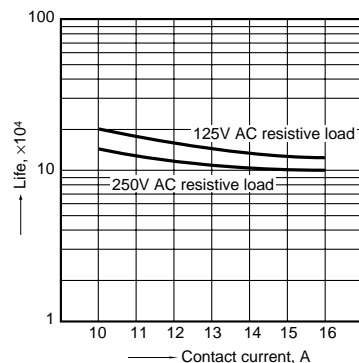

### 5-(1). Electrical life test

Sample: JL1aGF-TMP1-12V, 6 pcs.  
Load: AC 277 V, 16 A, resistive load  
Operation frequency: 20 cpm  
(ON:OFF = 1.5 s:1.5 s)  
Ambient temperature : 26°C 79°F  
circuit:

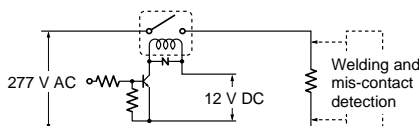

### Change of pick-up and Drop-out voltage

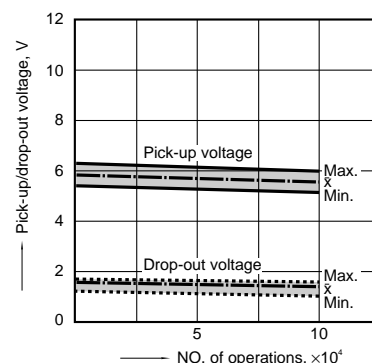

### 5-(2). Electrical life test

Sample: JL1aZF-TMP1-12V, 5 pcs.  
Load: AC 125 V, 12 A  
Operation frequency: 20 cpm  
(ON:OFF = 1.5s:1.5 s)  
Ambient temperature : 80°C 176°F

Circuit: (with coil diode protection)

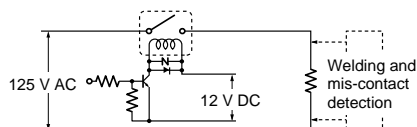

### Change of pick-up and Drop-out voltage

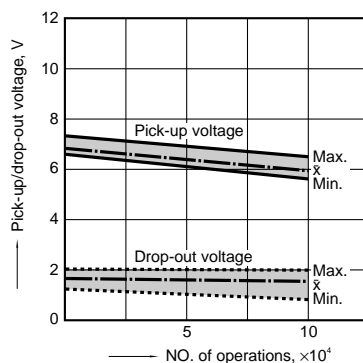

5-(3). Electrical life test

Sample: JL1aGF-TMP1-12V, 5 pcs.  
 Load: AC 125 V, 13 A  
 Operation frequency: 20 cpm  
 (ON:OFF = 1.5 s:1.5 s)  
 Ambient temperature : 90°C 194°F

Change of pick-up and Drop-out voltage

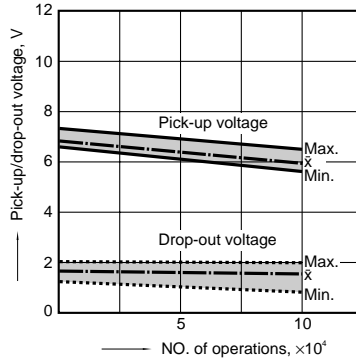

Circuit: (with coil diode protection)

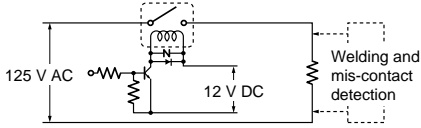

**DIMENSIONS**

1. Slim type

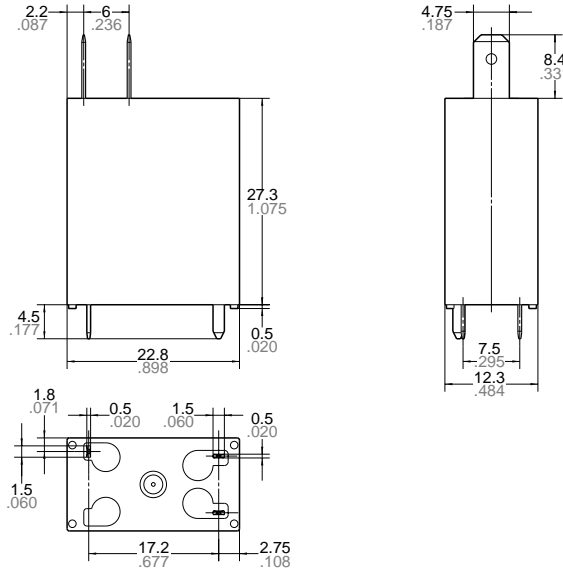

Schematic (Bottom view)

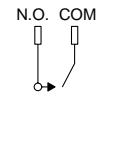

PC board pattern (Bottom view)

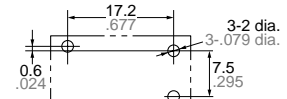

Tolerance  $\pm 0.3 \pm .012$

2. Flat type

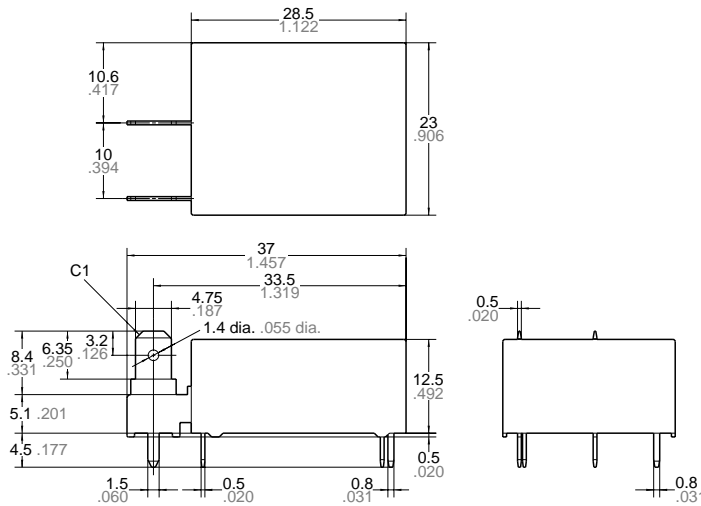

Schematic (Bottom view)

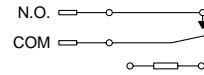

PC board pattern (Bottom view)

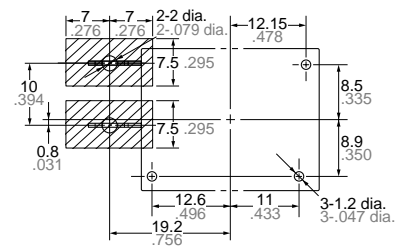

This product should only be used when there is no patterned metal surface (other than the terminal pattern) on the PC board facing the marked area .

Tolerance  $\pm 0.3 \pm .012$

**NOTES**

The rated contact capacity and life are typical values. Since contact phenomena and life vary depending on kinds of load and other conditions, please examine them through actual conditions.

Take particular care with the load in the following cases:

- When switching an alternating load, if the switching phase is synchrono with the load, locking and welding may occur.

- When switching loads at high frequency, arcing during switching may produce gases that can corrode metal parts.