

<h1>NAiS</h1>	TWO SERIES LINE-UP OF IMPEDANCE 50Ω AND 75Ω	<h1>RZ-COAXIAL SWITCHES</h1>
---------------	--	----------------------------------



FEATURES

1. Two series line-up of impedance 50Ω and 75Ω
2. Mechanical switch with superb high-frequency characteristics.
3. Low profile type package

TYPICAL APPLICATIONS

1. Cellular phone base stations (IMT-2000)
2. Digital broadcast equipment
3. Test measurement equipment

STANDARD PRODUCTS

	Circuit arrangement	Impedance	Frequency	Connector
50Ω series	DPDT bypass	50Ω	to 2.5 GHz	SMA
	SP4T			
75Ω series	SP4T with termination	75Ω	to 1.5 GHz	BNC-J
	Transfer			

CUSTOM PRODUCTS

RZ coaxial switches can be customized.

From the point of view of pricing and delivery we recommend our standard products, however, you may contact us if you require a circuit configuration that differs from the products above. Please understand that, depending on the conditions, we may not be able to customize in some cases.

RZ(ARZ1,2)

DPDT switch internal connection (bypass) type
(50Ω, to 2.5 GHz)

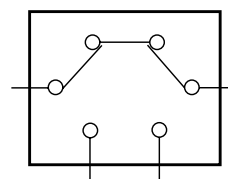
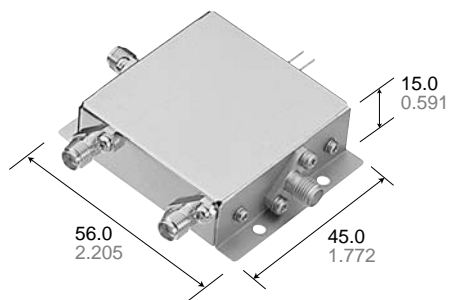

(mm inch)

ORDERING INFORMATION

Ex. ARZ 2 2 0 M

Product name	Contact arrangement	Operating function and impedance	Added function	Operating voltage, V DC
RZ coaxial switches	22: DPDT	0: Failsafe (50Ω)	M: Bypass	05: 5 12: 12 24: 24

PRODUCT TYPES

Operating voltage (Vcc)	Part No.
	Failsafe
5 V DC	ARZ220M05
12 V DC	ARZ220M12
24 V DC	ARZ220M24

SPECIFICATIONS

1. Characteristics

High frequency characteristics (to 2.5 GHz, Impedance 50Ω) (Initial)	Impedance	50Ω
	Insertion loss	Max. 1.0 dB
	Isolation	Min. 60 dB
	V.S.W.R.	Max. 1.5
	Input power	20 W
Electrical characteristics	Operating voltage	Vcc±5%
	Operate time	10 ms (excluding contact bounce time)
Expected life (min. operations)	Electrical	5 × 10 ⁴
Ambient temperature	Operate	0°C to +50°C 32°F to +122°F
	Storage	-10°C to +60°C +14°F to +140°F
Others	Connector	SMA

REFERENCE DATA

1. High frequency characteristics

• Insertion loss

(Through and between terminal 1 to 3)

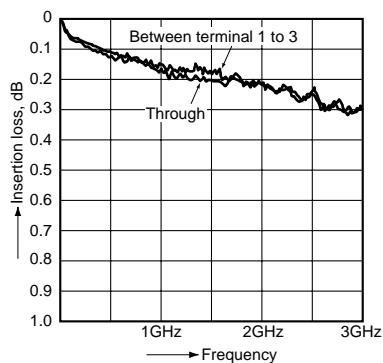

• Isolation

(Between terminal 1 to 3)

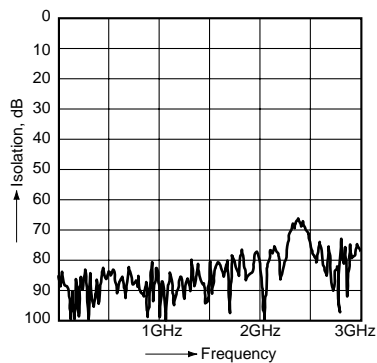

• V.S.W.R.

(Through and between terminal 1 to 3)

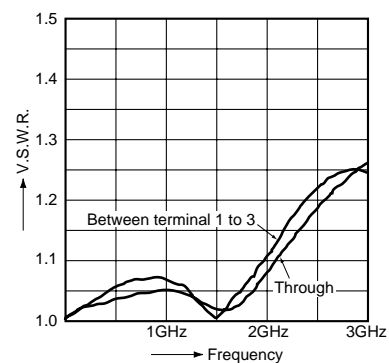

DIMENSIONS

mm inch

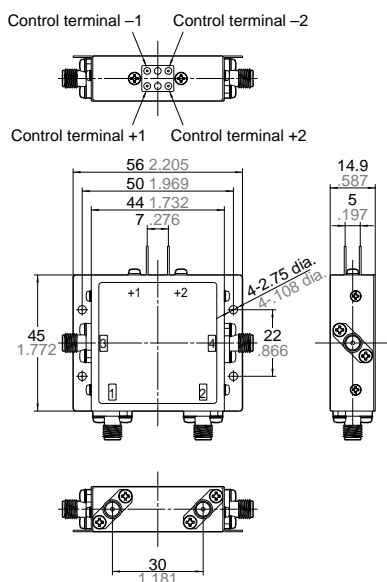

Equivalent circuit

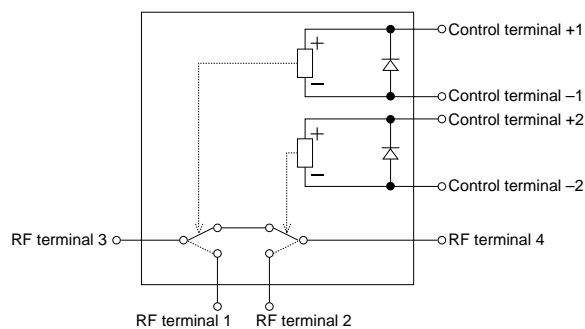

Switching operation table

RF terminal path (SMA)	Control terminal
3 to 4 (1, 2: no connection)	None
1 to 3 2 to 4	Control terminal +1, +2 → Vcc Control terminal -1, -2 → Gnd

Note) Do not apply multiple control signals simultaneously.

RZ(ARZ1,2)

SP4T switch
(50Ω, to 2.5 GHz)

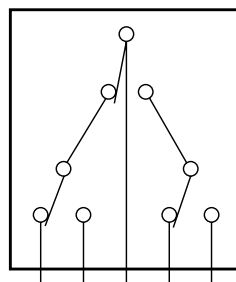
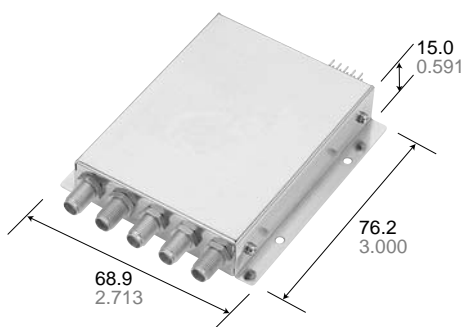

(mm inch)

ORDERING INFORMATION

Ex. ARZ 1 4 0 N

Product name	Contact arrangement	Operating function and impedance	Added function	Operating voltage, V DC
RZ coaxial switches	14: SP4T	0: Failsafe (50Ω)	N: None	05: 5 12: 12 24: 24

PRODUCT TYPES

Operating voltage (Vcc)	Part No.
	Failsafe
5 V DC	ARZ140N05
12 V DC	ARZ140N12
24 V DC	ARZ140N24

SPECIFICATIONS

1. Characteristics

High frequency characteristics (to 2.5 GHz, Impedance 50Ω) (Initial)	Impedance	50Ω
	Insertion loss	Max. 0.6 dB
	Isolation	Min. 60 dB
	V.S.W.R.	Max. 1.5
	Input power	20 W
Electrical characteristics	Operating voltage	Vcc±5%
	Operate time	10 ms (excluding contact bounce time)
Expected life (min. operations)	Electrical	5 × 10 ⁴
Ambient temperature	Operate	0°C to +50°C 32°F to +122°F
	Storage	-10°C to +60°C +14°F to +140°F
Others	Connector	SMA

REFERENCE DATA

1. High frequency characteristics

• Insertion loss

(Between terminal C to 3)

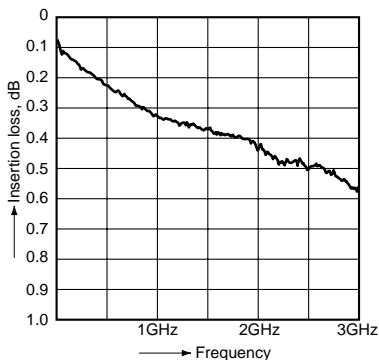

• Isolation

(Between terminal C to 3)

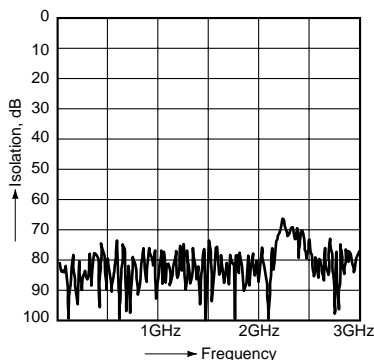

• V.S.W.R.

(Between terminal C to 3)

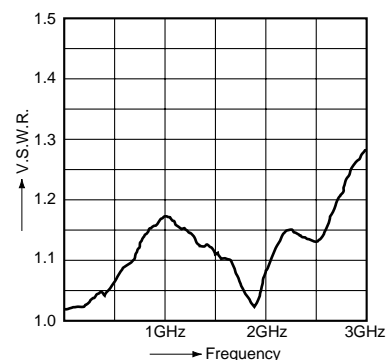

DIMENSIONS

mm inch

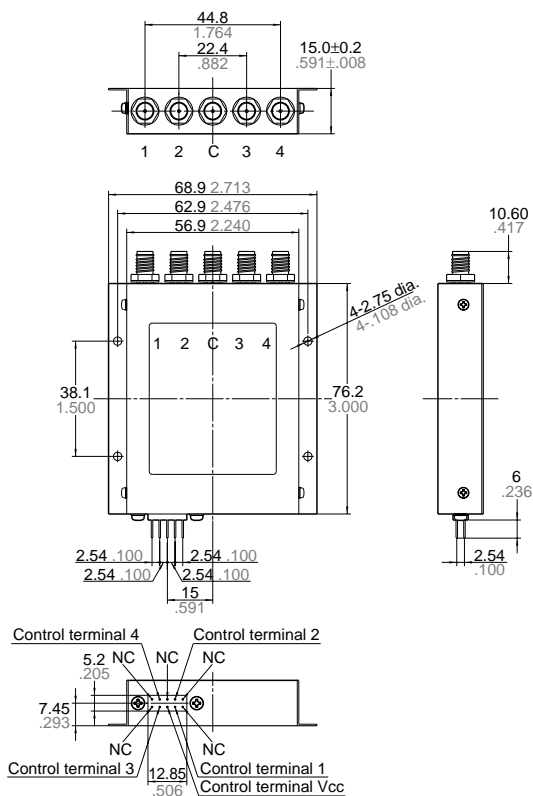

Equivalent circuit

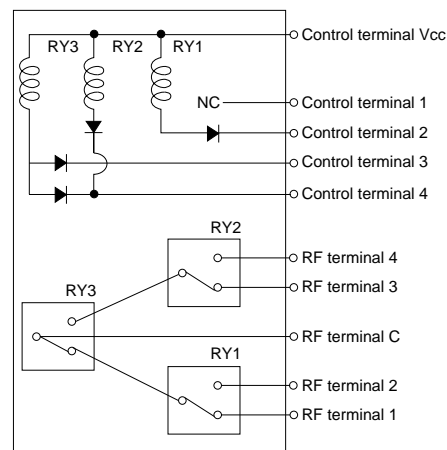

Switching operation table

RF terminal path (SMA)	Control terminal
C to 1	NC
C to 2	Control terminal Vcc → Vcc±5%, control terminal 2 → Gnd
C to 3	Control terminal Vcc → Vcc±5%, control terminal 3 → Gnd
C to 4	Control terminal Vcc → Vcc±5%, control terminal 4 → Gnd

Note) Do not apply multiple control signals simultaneously.

RZ(ARZ1,2)

SP4T switch with termination
(75Ω, to 1.5 GHz)

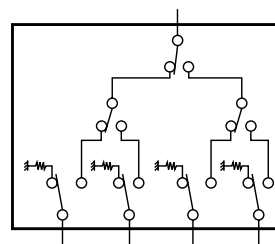
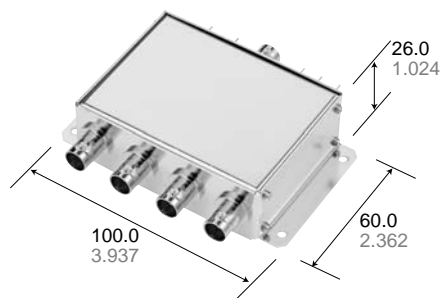

(mm inch)

ORDERING INFORMATION

Ex. ARZ 1 4 5 T

Product name	Contact arrangement	Operating function and impedance	Added function	Operating voltage, V DC
RZ coaxial switches	14: SP4T	5: Failsafe (75Ω)	T: With termination	05: 5 12: 12 24: 24

PRODUCT TYPES

Operating voltage (Vcc)	Part No.
5 V DC	ARZ145T05
12 V DC	ARZ145T12
24 V DC	ARZ145T24

SPECIFICATIONS

1. Characteristics

High frequency characteristics (to 1.5 GHz, Impedance 75Ω) (Initial)	Impedance	75Ω
	Insertion loss	Max. 1.0 dB
	Isolation	Min. 40 dB
	Return loss	Min. 18 dB
	Input power	1 W
Electrical characteristics	Operating voltage	Vcc±5%
	Operate time	10 ms (excluding contact bounce time)
	Termination operating power	0.5 W
Expected life (min. operations)	Electrical	5 × 10 ⁴
Ambient temperature	Operate	0°C to +50°C 32°F to +122°F
	Storage	-10°C to +60°C +14°F to +140°F
Others	Connector	BNC-J

REFERENCE DATA

1. High frequency characteristics

• Insertion loss

(Between terminal C to 2)

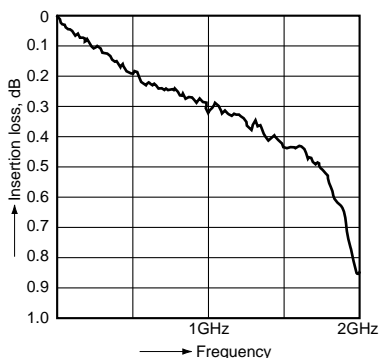

• Isolation

(Between terminal C to 2)

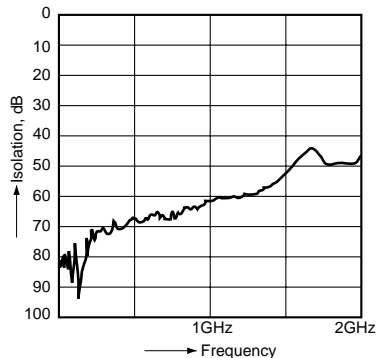

• Return loss

(Between terminal C to 2)

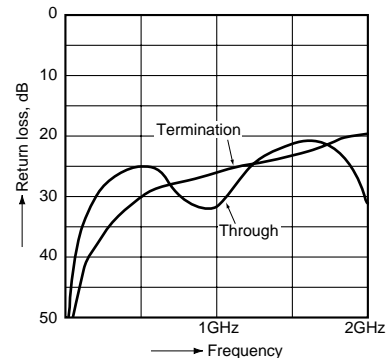

DIMENSIONS

mm inch

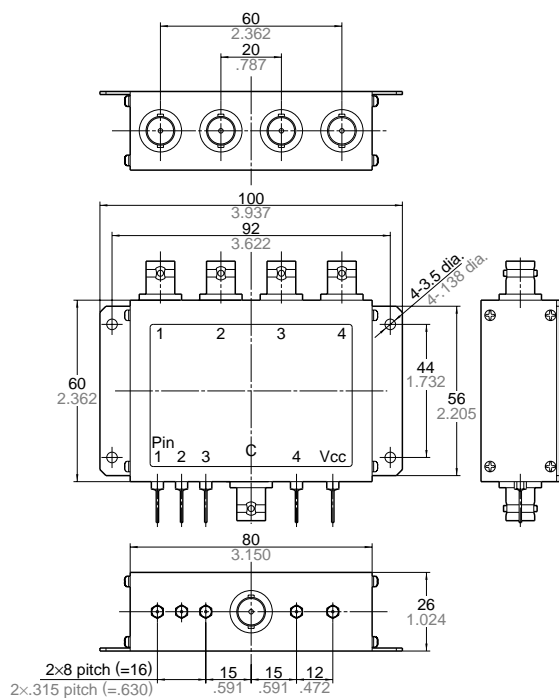

Switching operation table

RF terminal path (BNC-J)	Control terminal
C to 1	Control terminal Vcc → Vcc±5%, control terminal 1 → Gnd
C to 2	Control terminal Vcc → Vcc±5%, control terminal 2 → Gnd
C to 3	Control terminal Vcc → Vcc±5%, control terminal 3 → Gnd
C to 4	Control terminal Vcc → Vcc±5%, control terminal 4 → Gnd

Note) Do not apply multiple control signals simultaneously.

General tolerance: ±1.0 ±.039

RZ(ARZ1,2)

Transfer switch
(75Ω, to 1.5 GHz)

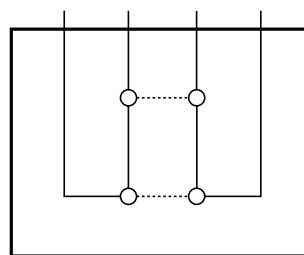
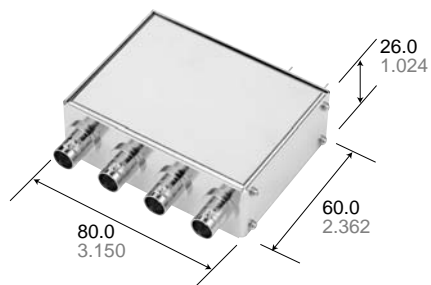

(mm inch)

ORDERING INFORMATION

Ex. ARZ 2 2 5 C

Product name	Contact arrangement	Operating function and impedance	Added function	Operating voltage, V DC
RZ coaxial switches	22: Transfer or DPDT	5: Failsafe (75Ω)	C: Transfer	05: 5 12: 12 24: 24

PRODUCT TYPES

Operating voltage (Vcc)	Part No.
	Failsafe
5 V DC	ARZ225C05
12 V DC	ARZ225C12
24 V DC	ARZ225C24

SPECIFICATIONS

1. Characteristics

High frequency characteristics (to 1.5 GHz, Impedance 75Ω) (Initial)	Impedance	75Ω
	Insertion loss	Max. 1.0 dB
	Isolation	Min. 35 dB
	Return loss	Min. 15 dB
	Input power	1 W
Electrical characteristics	Operating voltage	Vcc±5%
	Operate time	10 ms (excluding contact bounce time)
Expected life (min. operations)	Electrical	5 × 10 ⁴
Ambient temperature	Operate	0°C to +50°C 32°F to +122°F
	Storage	-10°C to +60°C +14°F to +140°F
Others	Connector	BNC-J

REFERENCE DATA

1. High frequency characteristics

• Insertion loss

(Between terminal 1 to 2)

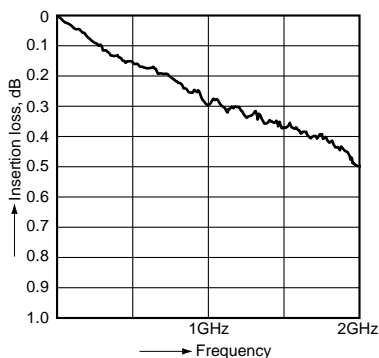

• Isolation

(Between terminal 1 to 2)

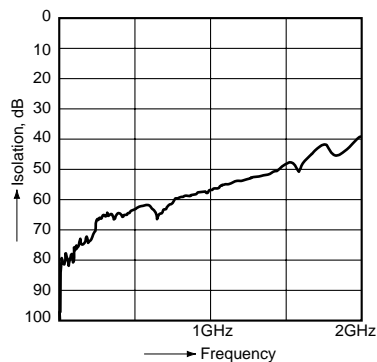

• Return loss

(Between terminal 1 to 2)

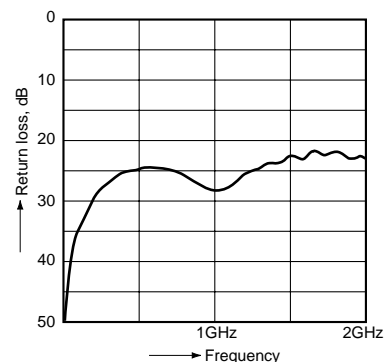

DIMENSIONS

mm inch

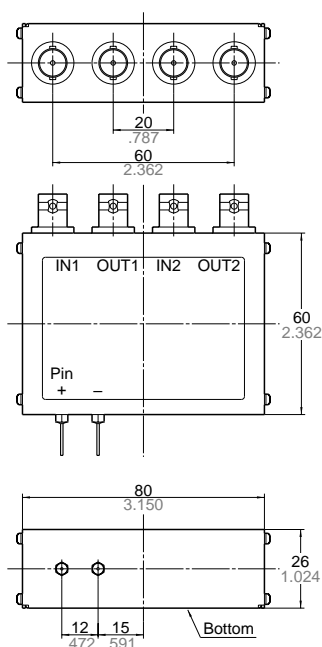

Mounting dimensions

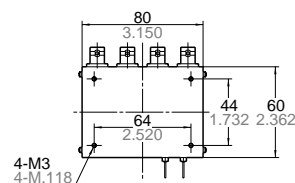

Equivalent circuit

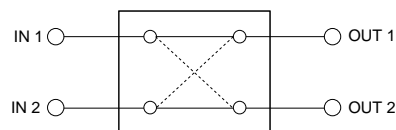

Switching operation table

RF terminal path (SMA)	Control terminal
IN1 — OUT1 IN2 — OUT2	NC
IN1 — OUT2 IN2 — OUT1	Control terminal + → Vcc Control terminal - → Gnd

Note) Do not apply multiple control signals simultaneously.

General tolerance: $\pm 1.0 \pm .039$

Note) The length of the screw which enters in this switch is 7 mm
.276 inch max.

For Cautions for Use, see Relay Technical Information in catalog.