

Water Detection Sensor EZ-10 Series

Thank you very much for using Panasonic products. Read this Instruction Manual carefully and thoroughly for the correct and optimum use of this product. Kindly keep this manual in a convenient place for quick reference.



- Never use this product as a sensing device for personnel protection.
- In case of using sensing devices for personnel protection, use products which meet laws and standards, such as OSHA, ANSI or IEC etc., for personnel protection applicable in each region or country.

1 SPECIFICATIONS

Type	NPN output type	PNP output type
Item	Model No. (Note 1)	Model No. (Note 1)
	EZ-11	EZ-11-PN
Sensing range	5m (without container or pipe) (Note 2)	
Sensing object	φ 12mm, or more, liquid which contains water, or opaque object	
Supply voltage	12 to 24V DC ±10% Ripple P-P 10% or less	
Current consumption	Emitter: 25mA or less, Receiver: 25mA or less	
Output	NPN open-collector transistor	PNP open-collector transistor
	<ul style="list-style-type: none"> • Maximum sink current: 100mA • Applied voltage: 30V DC or less (between output and 0V) • Residual voltage: 1.5V or less (at 100mA sink current) 0.4V or less (at 16mA sink current) 	<ul style="list-style-type: none"> • Maximum source current: 100mA • Applied voltage: 30V DC or less (between output and +V) • Residual voltage: 1.5V or less (at 100mA source current) 0.4V or less (at 16mA source current)
Output operation	Switchable either Light-ON or Dark-ON	
Short-circuit protection	Incorporated	
Response time	12ms or less	
Operation indicator	Orange LED (lights up when the output is ON), located on the receiver	
Stability indicator	Green LED (lights up under stable light condition or stable dark condition), located on the receiver	
Power indicator	Orange LED (lights up when the power is ON), located on the emitter	
Sensitivity adjuster	Continuously variable adjuster	
Protection	IP67 (IEC)	
Ambient temperature	0 to +55°C (No dew condensation), Storage: -30 to +70°C	
Ambient humidity	35 to 85% RH, Storage: 35 to 85% RH	
Emitting element	Infrared LED (modulated)	
Material	Polycarbonate	
Cable	0.2mm ² 3-core (emitter: 2-core) oil resistant cable, 2m long	
Weight	Emitter: 45g approx., Receiver: 50g approx.	
Accessory	Adjusting screwdriver: 1pc.	

Notes: 1) The model No. with suffix '-J' stands for the plug-in connector type.
Model No.: **EZ-11-J**, **EZ-11-PN-J**
Use the mating cables as shown below. (Two sets are required.)
(The white wire is not to be connected.)

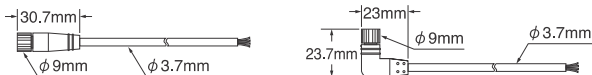

CN-24E-C2 (Straight type, 4-core, 2m long) **CN-24EL-C2** (Elbow type, 4-core, 2m long)
CN-24E-C5 (Straight type, 4-core, 5m long) **CN-24EL-C5** (Elbow type, 4-core, 5m long)

The model No. with suffix '-C5' stands for the 5m cable length type.
Model No.: **EZ-11-C5**, **EZ-11-PN-C5**

The model No. with suffix 'P' shown on the label is the emitter, 'D' shown on the label is the receiver.

Emitter: **EX-11P**, Receiver: **EX-11D**

- 2) The sensing range shortens depending on the thickness, material, color, etc., of the container or pipe.

2 MOUNTING

- The tightening torque should be 0.5N·m or less.

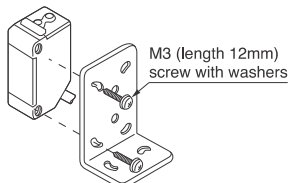

Sensor mounting bracket (optional)
MS-CX2-1

3 CAUTIONS

- This product has been developed / produced for industrial use only.
- Make sure that the power supply is off while wiring.
- Take care that wrong wiring will damage the sensor.
- Verify that the supply voltage variation is within the rating.
- If power is supplied from a commercial switching regulator, ensure that the frame ground (F.G.) terminal of the power supply is connected to an actual ground.
- In case noise generating equipment (switching regulator, inverter motor, etc.) is used in the vicinity of this product, connect the frame ground (F.G.) terminal of the equipment to an actual ground.
- Do not run the wires together with high-voltage lines or power lines or put them in the same raceway. This can cause malfunction due to induction.
- Do not use during the initial transient time (100ms) after the power supply is switched on.
- Take care that the sensor is not directly exposed to fluorescent lamp from a rapid-starter lamp, a high frequency lighting device or sunlight etc., as it may affect the sensing performance.
- Extension up to total 100m (both emitter and receiver), or less, is possible with 0.3mm², or more, cable.
- Make sure that stress by forcible bend or pulling is not applied to the sensor cable joint.
- When connecting the mating cable to the connector type sensor, the tightening torque should be 0.4N·m or less.
- This sensor is suitable for indoor use only.
- Do not use this sensor in places having excessive vapor, dust, etc., or where it may come in direct contact with water, or corrosive gas.
- Take care that the sensor does not come in contact with water, oil, grease, organic solvents, such as, thinner etc., strong acid or alkaline.
- The special emitting and receiving elements used in this product are easily affected by changes in ambient temperature and humidity. Hence, do the sensitivity adjustment under the actual operating conditions.

4 I/O CIRCUIT DIAGRAMS

● NPN output type

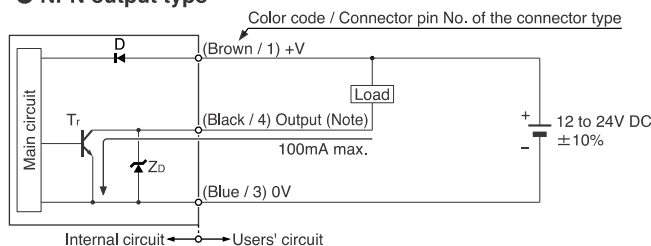

Note: The emitter does not incorporate the output.

Symbols ... D : Reverse supply polarity protection diode
Z_o : Surge absorption zener diode
Tr : NPN output transistor

● PNP output type

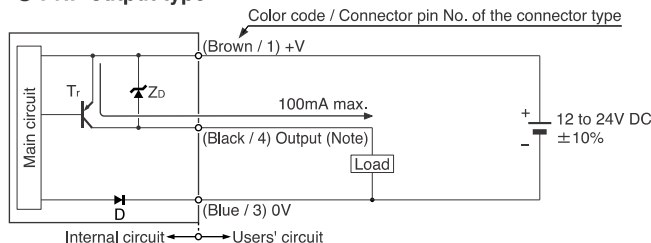

Note: The emitter does not incorporate the output.

Symbols ... D : Reverse supply polarity protection diode
Z_o : Surge absorption zener diode
Tr : PNP output transistor

● Connector pin position (plug-in connector type)

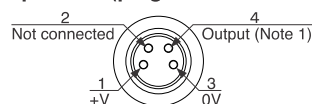

Notes: 1) The emitter does not incorporate the output.

- 2) When the mating cable is connected to the plug-in connector type sensor, the white wire of the mating cable is not connected.

5 ADJUSTMENTS

● Top face

Operation indicator (Orange) (Note 1)
Lights up when the output is ON.

Stability indicator (Green) (Note 2)
Lights up under the stable light received condition or the stable dark condition.

Operation mode switch (Note 2)
L: Light-ON
D: Dark-ON
(Turn the switch till it stops.)

Sensitivity adjuster (Note 2)
Sensing range increases when turned clockwise.

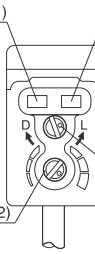

Notes: 1) It is the power indicator (orange) (lights up when the power is ON) for the emitter.
2) It is not incorporated on the emitter.

● Operation mode switch

Operation mode switch	Operation
	Light-ON mode is obtained when the switch is turned fully counterclockwise (L side).
	Dark-ON mode is obtained when the switch is turned fully clockwise (D side).

● Light beam alignment

- Set the operation mode switch to the Light-ON mode position (L side).
- Placing the emitter and the receiver face to face along a straight line, move the emitter in the up, down, left and right directions, in order to determine the range of the light received condition with the help of the operation indicator (orange). Then, set the emitter at the center of this range.
- Similarly, adjust for up, down, left and right angular movement of the emitter.
- Further, perform the angular adjustment for the receiver also.
- Check that the stability indicator (green) lights up.
- Choose the operation mode, Light-ON or Dark-ON, as per your requirement, with the operation mode switch.

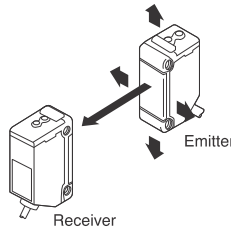

● Sensitivity adjustment (Should be done under actual operating conditions.)

Step	Sensitivity adjuster	Operation
①		Turn the sensitivity adjuster fully counterclockwise to the minimum sensitivity position, MIN.
②		With the liquid which contains water or the opaque object absent (light received condition), turn the sensitivity adjuster slowly and confirm the point A where the sensor enters the 'Light' state operation.
③		With the liquid which contains water or the opaque object present (light interrupted condition), turn the sensitivity adjuster further clockwise until the sensor enters the 'Light' state operation and then bring it back to confirm point B where the sensor just returns to the 'Dark' state operation. (If the sensor does not enter the 'Light' state operation even when the sensitivity adjuster is turned fully clockwise, this extreme position is point B.)
④		The position at the middle of points A and B is the optimum sensing position.

Note: Use the accessory adjusting screwdriver to turn the adjuster slowly. Turning with excessive strength will cause damage to the adjuster.

Liquid which contains water absent (light received) condition		Liquid which contains water present (light interrupted) condition	
	Emitter	Receiver	Sensing object (water)
Transparent or translucent container		Transparent or translucent container	
Opaque object absent (light received) condition		Opaque object present (light interrupted) condition	
	Emitter	Receiver	Sensing object (Opaque object)
		(Opaque object)	

Relation between output and indicators

☼ : Lights up, ● : Turns off

In case of Light-ON (L)			In case of Dark-ON (D)			
Stability indicator	Operation indicator	Output	Sensing state	Output	Operation indicator	Stability indicator
☼	☼	ON	Stable light receiving	OFF	●	☼
●	☼	ON	Unstable light receiving	OFF	●	●
☼	●	OFF	Unstable light interrupted	ON	☼	☼
☼	●	OFF	Stable light interrupted	ON	☼	☼

6 SLIT MASK (OPTIONAL)

- Apply a slit mask for detecting small objects, or for improving interference prevention and sensing position accuracy. However, the sensing range is reduced when the slit mask is mounted.

How to mount

- Insert the fixing hook into the fixing groove.
- Then, pressing the slit mask against the main unit, insert the fixing tab into the fixing groove.

How to remove

- Insert a screwdriver into the removing tab.
- Pull forward while lifting the removing tab.

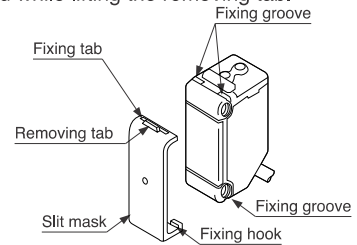

7 DIMENSIONS (Unit: mm)

● EZ-11-(PN) / Cable type

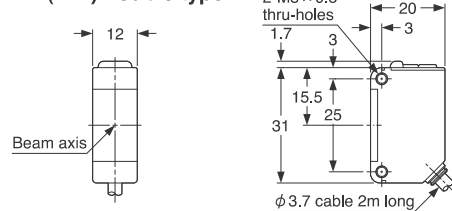

● EZ-11-(PN)-J / Plug-in connector type

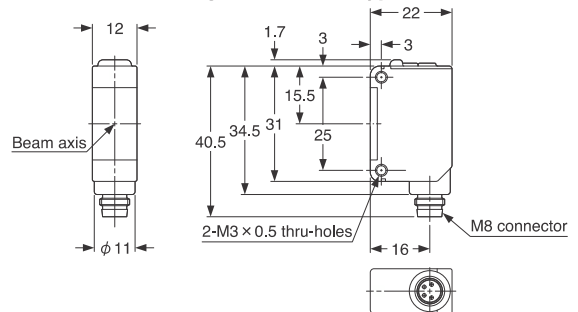

8 INTENDED PRODUCTS FOR CE MARKING

- The models listed under '1 SPECIFICATIONS' come with CE Marking.



As for all other models, please contact our office.

Panasonic Electric Works SUNX Co., Ltd.

<http://panasonic-electric-works.net/sunx>

Overseas Sales Division (Head Office)

2431-1 Ushiyama-cho, Kasugai-shi, Aichi, 486-0901, Japan
Phone: +81-568-33-7861 FAX: +81-568-33-8591

Europe Headquarter: Panasonic Electric Works Europe AG

Rudolf-Diesel-Ring 2, D-83607 Holzkirchen, Germany
Phone: +49-8024-648-0

US Headquarter: Panasonic Electric Works Corporation of America

629 Central Avenue New Providence, New Jersey 07974 USA
Phone: +1-908-464-3550

PRINTED IN JAPAN

© Panasonic Electric Works SUNX Co., Ltd. 2011