

**Digital Fiber Sensor For Leak Detection Fiber
FX-301(P)-F7**

MJE-FX301F7 No.0016-26V

Thank you very much for purchasing Panasonic products. Please read this Instruction Manual carefully and thoroughly for the correct and optimum use of this product. Kindly keep this manual in a convenient place for quick reference.

⚠ WARNING

- Never use this product as a sensing device for personnel protection.
- In case of using sensing devices for personnel protection, use products which meet laws and standards, such as OSHA, ANSI or IEC etc., for personnel protection applicable in each region or country.

1 PART DESCRIPTION

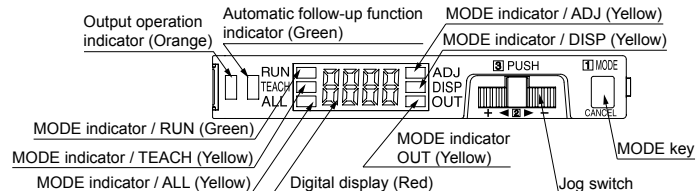

<Operating portion>

| MODE key | Jog switch | | |
|--|---------------------------|--------------------------|------------------|
| Press | Press | Turn to "+" side | Turn to "-" side |
| | | | |
| Used for mode selection or cancellation during setting. (Note) | Used to select each item. | Used to enter each item. | |

Note: When MODE key is pressed for 1 sec., or more, the sensor returns to the RUN mode. (in MAIN mode only)

2 MOUNTING

How to mount the amplifier

1. Fit the rear part of the mounting section of the amplifier on a 35mm width DIN rail.
2. Press down the rear part of the mounting section of the unit on the 35mm width DIN rail and fit the front part of the mounting section to the DIN rail.

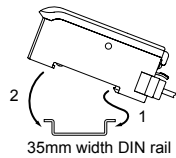

How to remove the amplifier

1. Push the amplifier forward.
2. Lift up the front part of the amplifier to remove it.

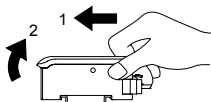

Note: Take care that if the front part is lifted without pushing the amplifier forward, the hook on the rear portion of the mounting section is likely to break.

How to connect the fiber cable

Make sure to connect the fiber attachment (FX-AT4), enclosed with the fiber, to the fibers. Refer to the instruction manual of the fiber attachment for the connecting method.

1. Snap the fiber lock lever down, till it stops completely.
2. Insert the fiber cables with the fiber attachment (FX-AT4) slowly into the fiber inlet till it stops (Note).
3. Return the fiber lock lever to the original position, till it stops.

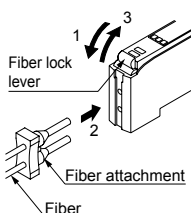

Note: Take care that in case the fiber cables are not inserted to a position where they stop, the sensing becomes unstable.

3 CONNECTION

Make sure to connect or disconnect the quick-connection cable in the power supply off condition.

Connection method

1. Holding the connector of the quick-connection cable, align its release lever with the groove at the top portion of the amplifier connector.
2. Insert the connector till a click is felt.

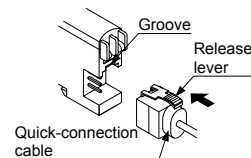

Disconnection method

1. Pressing the release lever at the top of the quick-connection cable connector, pull out the connector.

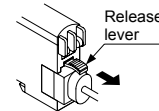

Note: Take care that if the connector is pulled out without pressing the release lever, the release lever may break. Do not use a quick-connection cable whose release lever has broken. Further, do not pull by holding the cable, as this can cause a cable-break.

<Terminal arrangement diagram>

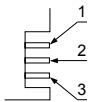

| Terminal No. | Terminal name |
|--------------|---------------|
| 1 | +V |
| 2 | Output |
| 3 | 0V |

4 CASCADING AMPLIFIERS

- Make sure that the power supply is off while adding or removing the amplifiers.
- Make sure to check the allowable ambient temperature, as it depends on the number of amplifiers connected in cascade.
- In case two, or more, amplifiers are connected in cascade, make sure to mount them on a DIN rail.
- When the amplifiers move on the DIN rail depending on the attaching condition or the amplifiers are mounted close to each other in cascade, fit them between the optional end plates (MS-DIN-E) mounted at the two ends.
- Up to maximum 15 amplifiers can be added (total 16 amplifiers connected in cascade).
- When connecting more than two amplifiers in cascade, use the sub cable (CN-71-C) as the quick-connection cable for the second amplifier onwards.
- When connecting amplifiers not close to each other in parallel, be sure to mount the optional end plate (MS-DIN-E) at both sides of each amplifier or affix the communication window seal of the accessory amplifier protection seal (FX-MB1) to the communication windows.
- Communication function is different between this amplifier and other digital fiber amplifier. If those amplifiers are mounted in cascade, affix the communication window seal of the accessory amplifier protection seal (FX-MB1) to the communication windows.
- In case of conducting collective teaching by mounting this product and FX-301-F in cascade, be sure to set FX-301-F to the leak detection function. Note that the collective teaching cannot be done if using FX-301-F which has been set to the liquid detection function.
- In case of cascading, wait for 10 minutes, or more, to use the teaching function after the power is switched on.

For mounting and removing the amplifier, refer to "2 MOUNTING."

Cascading method

1. Mount the amplifiers, one by one, on the 35mm width DIN rail.
2. Slide the amplifiers next to each other, and connect the quick-connection cables.
3. Mount the optional end plates (MS-DIN-E) at both the ends to hold the amplifiers between their flat sides.
4. Tighten the screws to fix the end plates.

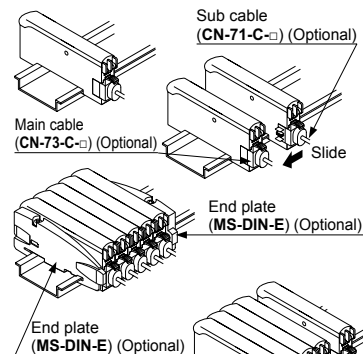

Dismantling method

1. Loosen the screws of the end plates.
2. Remove the end plates.
3. Slide the amplifiers and remove them one by one.

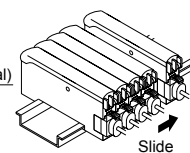

5 I/O CIRCUIT DIAGRAMS

<NPN output type>

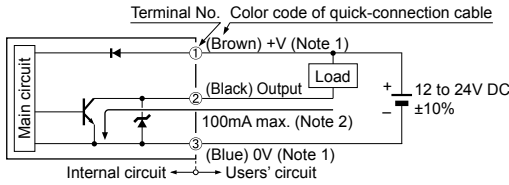

<PNP output type>

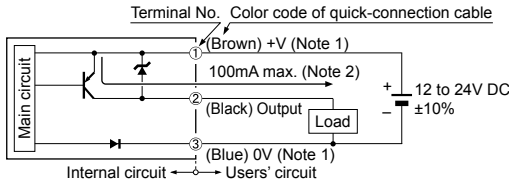

- Notes: 1) The quick-connection sub cable does not have +V (brown) and 0V (blue). The power is supplied from the connector of the main cable.
 2) 50mA max. if five, or more, amplifiers are connected together.
 3) Do not use the amplifiers in a series (AND) connection.

6 OPERATION PROCEDURE

- When the power supply is switched on, normal condition is displayed [MODE indicator / RUN (green) lights up] and the digital display (red) shows the incident light intensity.
- When MODE key is pressed, the mode changes as per the diagram below.

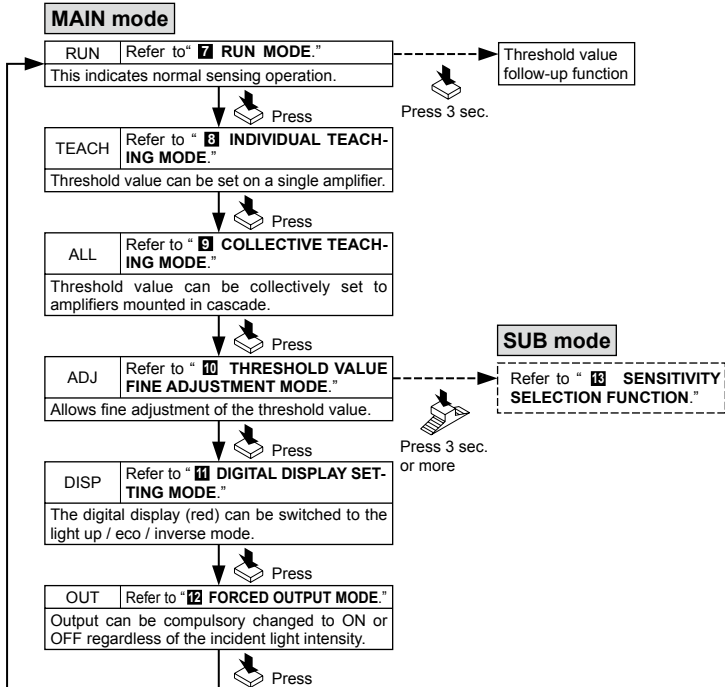

7 RUN MODE

- When MODE indicator / RUN (green) lights up, the display setting or the sensitivity select setting can be checked. Refer to "13 SENSITIVITY SELECTION FUNCTION" for further details of sensitivity select setting.

How to change to "percentage display"

- When pressing Jog switch for 2 sec., or more, the display changes as per the diagram below.

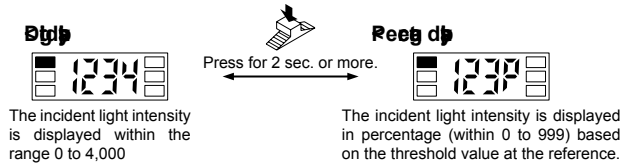

How to check the sensitivity state

- If turning Jog switch to "+" or "-" side, the present sensitivity state can be confirmed. After 2 sec., the display returns to "digit display" or "percentage display."

LO mode>

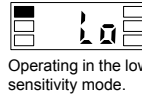

Or

HI mode>

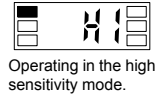

Threshold value follow-up function

- When incident light intensity exceeds threshold value, this mode can change the threshold value with a constant cycle depending on variations of the incident light intensity. The follow-up shift amount is same as the one set in the shift setting mode. However, the threshold value is not stored.

| Step | Digital display | Description |
|------|-----------------|--|
| 1 | 1234 | • Insert leak detection fiber (FD-F705) into this product. |
| 2 | 1234 | • Press down MODE key for 3 seconds in RUN mode. |
| 3 | 1234 | <ul style="list-style-type: none"> Indicated as "1234" (automatic follow-up is OFF). Turn Jog switch to "+" or "-" side to indicate "1234" (automatic follow-up is ON). When "1234" (automatic follow-up is ON) is set, the automatic follow-up function indicator (green) lights up. |
| 4 | 1234 | • Press Jog switch to back to RUN mode. |

8 INDIVIDUAL TEACHING MODE

The sensitivity selection function is set to the automatic sensitivity setting "Auto" at the time of factory shipment. In case sensitivity selection setting is done, make sure to carry out "teaching" after the sensitivity selection setting.

For the sensitivity selection setting, refer to "13 SENSITIVITY SELECTION FUNCTION."

- When MODE indicator / TEACH (yellow) lights up, threshold value can be set on a single unit.

| Step | Digital display | Description |
|------|-----------------|--|
| 1 | 1234 | • Insert leak detection fiber (FD-F705) into this product. |
| 2 | 5F-2 | <ul style="list-style-type: none"> Press MODE key to light up MODE indicator / TEACH (yellow). Shift amount of the threshold value can be changed by turning Jog switch to "+" or "-" side. While changing, the digital display (red) blinks. 5F-1: Shift approx. 15% 5F-2: Shift approx. 20% (At factory setting) 5F-3: Shift approx. 30% |
| 3 | 0000 | • Press Jog switch to start teaching. |
| 4 | 0000 | <ul style="list-style-type: none"> When teaching is accepted, the result of threshold value setting is displayed. In case stable sensing is possible: "0000" on the digital display (red) blinks 3 times. In case stable sensing is not possible: "5F-3" on the digital display (red) blinks. (Note) The shift amount set in the step 2 will revert to the first shift amount before setting. |
| 5 | 1234 | <ul style="list-style-type: none"> If the teaching result is "0000", the sensor returns to RUN mode automatically and the incident light intensity is shown on the digital display (red). MODE indicator / RUN (green) lights up. The setting is complete. |

Note: For details, refer to "14 ERROR INDICATION."

9 COLLECTIVE TEACHING MODE

- When MODE indicator / ALL (yellow) lights up, a threshold value can be collectively set to amplifiers mounted in cascade.

| Step | Digital display | Description |
|------|-----------------|---|
| 1 | | • Insert leak detection fiber (FD-F705) into this product. |
| 2 | | • Press MODE key to light up MODE indicator / ALL (yellow). • Shift amount of the threshold value can be changed by turning Jog switch to "+" or "-" side. While changing, the digital display (red) blinks. 5F-1: Shift approx. 15% 5F-2: Shift approx. 20% (At factory setting) 5F-3: Shift approx. 30% |
| 3 | | • Press Jog switch to start teaching. |
| 4 | | • When teaching is accepted, the result of threshold value setting is displayed. In case stable sensing is possible: "9000" on the digital display (red) blinks 3 times. In case stable sensing is not possible: "5F-3" on the digital display (red) blinks. (Note 1) The shift amount set in the step 2 will revert to the first shift amount before setting. |
| 5 | | • If the teaching result is "9000," the sensor returns to RUN mode automatically and the incident light intensity is shown on the digital display (red). • MODE indicator / RUN (green) lights up. • The setting is complete. |

- Notes: 1) For details, refer to "❏ ERROR INDICATION."
2) In collective teaching, only an instruction of the teaching operation is transmitted, the threshold value is not copied. The threshold value taught at the respective amplifier is set.
3) When the collective teaching is done, the following setting conditions are copied. In case an individual setting condition is desired to be set, set it individually after the collective teaching.
• Digit / percentage display • Threshold value follow-up function • Shift amount
• Digital display setting • Sensitivity selection function
4) The collective teaching transmits the information only in the direction of the arrow shown on the following diagram. The collective teaching is also possible from the middle of the amplifiers mounted in cascade. Check the direction of the transmission before collective teaching is done.

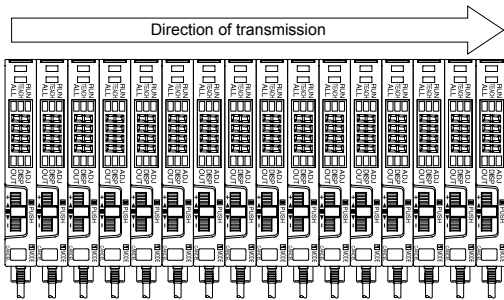

10 THRESHOLD VALUE FINE ADJUSTMENT MODE

- When MODE indicator / ADJ (yellow) lights up, the set threshold value can be fine adjusted.

| Step | Digital display | Description |
|------|-----------------|---|
| 1 | | • Press MODE key to light up MODE indicator / ADJ (yellow). |
| 2 | | • Turn Jog switch to "+" side, to increase the threshold value. • Turn Jog switch to "-" side, to decrease the threshold value. |
| 3 | | • When Jog switch is pressed, the changed threshold value blinks 3 times and is confirmed. |
| 4 | | • When MODE key is pressed 3 times, or for 1 sec., or more, the sensor returns to RUN mode and the incident light intensity is shown in the digital display (red). • MODE indicator / RUN (green) lights up. • The setting is complete. |

- Note: The adjustable area is limited as shown below. In order to adjust the threshold outside the adjustable area, confirm it within the area once and then adjust it again.

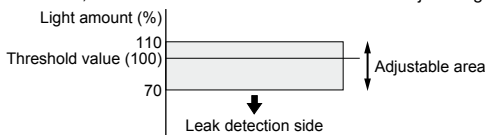

11 DIGITAL DISPLAY SETTING MODE

- When MODE indicator / DISP (yellow) lights up, the digital display (red) can be switched to the light-up mode, eco mode or inverse mode.

| Step | Digital display | Description |
|------|-----------------|---|
| 1 | | • Press MODE key to light up MODE indicator / DISP (yellow). |
| 2 | | • When Jog switch is turned to "+" side or "-" side, the mode in the digital display changes. 5c0f: This is the light-up mode in the digital display (red). The digital display (red) always lights up. 5c0n: This is the eco mode. After confirmation, if key operation has not been done for 8 sec., or more, "5c0a" flashes, and then the digital display (red) is turned off. When a key operation is done after the display is turned off or when the collective teaching is carried out, the digital display (red) lights up. 5u0n: This is the inverse mode of the digital display (red). In the normal display condition, the display changes to the inverse display and in the inverse condition, the display changes to the normal display. |
| 3 | | • When Jog switch is pressed, the set display blinks 3 times and is confirmed. |
| 4 | | • When MODE key is pressed twice or for 1 sec., or more, the sensor returns to RUN mode and the incident light intensity is displayed in the digital display (red). • MODE indicator / RUN (green) lights up. • The setting is complete. |

- Note: The initial setting at the time of factory shipment is the light-up mode "5c0f."

12 FORCED OUTPUT MODE

- When MODE indicator / OUT (yellow) lights up, the output can be compulsorily changed to ON or OFF regardless of the incident light intensity.

| Step | Digital display | Description |
|------|-----------------|--|
| 1 | | • Press MODE key to light up MODE indicator / OUT (yellow). (Present output state is displayed.) |
| 2 | | • When Jog switch is turned to "+" side or "-" side, the output is compulsorily changed to ON or OFF. • Since the emitting element of the amplifier blinks, it is possible to check the fiber connected to the amplifier. • When the output is compulsorily changed to ON, the operation indicator (orange) lights up. |
| 3 | | • Press MODE key to return the sensor to Step 1. |
| 4 | | • When MODE key is pressed, the sensor returns to RUN mode and the incident light intensity is displayed in the digital display (red). • MODE indicator / RUN (green) lights up. |

13 SENSITIVITY SELECTION FUNCTION

- If Jog switch is pressed for 3 sec., or more, when MODE indicator / ADJ (yellow) lights up, the sensitivity can be fixed to low sensitivity or high sensitivity, or set to automatic sensitivity.

| Step | Digital display | Description |
|------|-----------------|---|
| 1 | | • Press MODE key to light up MODE indicator / ADJ (yellow). |
| 2 | | • Press Jog switch for 3 sec. or more. (The sensor goes into the sensitivity setting condition.) • MODE indicator / RUN (green) blinks. |
| 3 | | • When turning Jog switch to "+" side or "-" side, the digital display (red) and MODE indicator / RUN (green) blinks, and the sensitivity can be selected. 9ut0: Automatic sensitivity setting After selecting the automatic sensitivity, the optimum sensitivity is set by carrying out teaching. 10: Low sensitivity setting H1: High sensitivity setting |
| 4 | | • When Jog switch is pressed, the setting display blinks 3 times and is confirmed. |
| 5 | | • MODE indicator / TEACH (yellow) lights up and "5F-1," "5F-2" or "5F-3" is displayed in the digital display (red). • After sensitivity selection, carry out the teaching. • For the setting method of teaching, refer to "❏ INDIVIDUAL TEACHING MODE." |

- Note: The initial setting at the time of factory shipment is the automatic sensitivity setting "9ut0."

14 ERROR INDICATION

- When an error is displayed, remedy as follows.

| Error indication | Cause | Remedy |
|------------------|---|--|
| | Excessive current flows due to a short-circuit. | Switch off the power supply and check the load. |
| | The teaching is abnormal. | <ul style="list-style-type: none"> Check the installation condition of the fiber, or whether the fiber has come out, and then do teaching again. Press MODE key to cancel "E-3." After the cancellation, the sensor operates at the set value conditions before the error. However, in case the sensitivity selection function has been set to the automatic sensitivity setting "R_u," the sensor operates at optimum sensitivity. |
| | The communication is abnormal. | Check if the amplifiers mounted in cascade are disconnected. After the confirmation, do the teaching again. |

15 SPECIFICATIONS

| Type | NPN output type | PNP output type |
|--------------------------------------|--|--|
| Item Model No. | FX-301-F7 | FX-301P-F7 |
| Applicable fiber | FD-F705 | |
| Supply voltage | 12 to 24V DC±10% Ripple P-P 10% or less | |
| Power consumption | Normal operation: 960mW or less (Current consumption 40mA or less at 24V supply voltage) Eco-operation: 600mW or less (Current consumption 25mA or less at 24V supply voltage) | |
| Output | NPN open-collector transistor • Maximum sink current: 100mA (Note 1) • Applied voltage: 30V DC or less (between output and 0V) • Residual voltage: 1.5V or less [at 100mA (Note 1) sink current] | PNP open-collector transistor • Maximum source current: 100mA (Note 1) • Applied voltage: 30V DC or less (between output and +V) • Residual voltage: 1.5V or less [at 100mA (Note 1) source current] |
| Output operation | OFF when leak is detected. | |
| Short-circuit protection | Incorporated | |
| Response time | 500µs or less (Note 2) | |
| Sensitivity setting method | Individual teaching / Collective teaching | |
| Fine sensitivity adjustment function | Incorporated | |
| Ambient temperature | 0 to +50°C (If 8 to 16 units are connected together: 0 to +45°C) (No dew condensation or icing allowed), Storage: -20 to +70°C | |
| Ambient humidity | 35 to 85% RH, Storage: 35 to 85% RH | |
| Emitting element | Red LED (modulated) | |
| Material | Enclosure: Heat-resistant ABS, Transparent cover: Polycarbonate | |
| Weight | Approx. 20g | |

Notes: 1) 50mA if five, or more, amplifiers are connected together.

2) If a leak is detected (output: OFF), since the emission is put in blinking operation, only the response to return to ON gets delayed. (approx. 1 sec.)

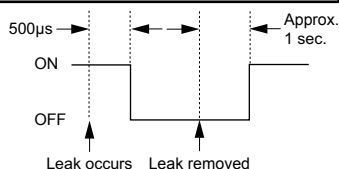

3) The cable for amplifier connection is not supplied as an accessory. Make sure to use the optional quick-connection cables given below.

Main cable (3-core):

CN-73-C1 (cable length 1m), **CN-73-C2** (cable length 2m), **CN-73-C5** (cable length 5m)

Sub cable (1-core):

CN-71-C1 (cable length 1m), **CN-71-C2** (cable length 2m), **CN-71-C5** (cable length 5m)

16 CAUTIONS

- This product has been developed / produced for industrial use only.
- Make sure that the power supply is off while wiring and cascading.
- Take care that if a voltage exceeding the rated range is applied, or if an AC power supply is directly connected, the sensor may get burnt or damaged.
- Take care that short-circuit of the load or wrong wiring may burn or damage the sensor.
- Do not run the wires together with high-voltage lines or power lines or put them in the same raceway. This can cause malfunction due to induction.
- Verify that the supply voltage variation is within the rating.
- If power is supplied from a commercial switching regulator, ensure that the frame ground (F.G.) terminal of the power supply is connected to an actual ground.
- In case noise generating equipment (switching regulator, inverter motor, etc.) is used in the vicinity of this product, connect the frame ground (F.G.) terminal of the equipment to an actual ground.
- Do not use during the initial transient time (0.5 sec.) after the power supply is switched on.
- Make sure to use the optional quick-connection cable for the connection of the amplifier. Extension up to total 100m is possible with 0.3mm², or more, cable. However, in order to reduce noise, make the wiring as short as possible.
- Make sure that stress by forcible bend or pulling is not applied directly to the sensor cable joint.
- Take care that the sensor is not directly exposed to fluorescent lamp from a rapid-starter lamp, a high frequency lighting device or sunlight etc., as it may affect the sensing performance.
- This sensor is suitable for indoor use only.
- Avoid dust, dirt, and steam.
- Take care that the product does not come in contact with oil, grease, organic solvents, such as thinner, etc., strong acid or alkaline.
- When the fiber head gets dusty or dirty etc. the sensitivity deteriorates. To keep stable detection, wipe the fiber head to remove dust or dirt etc. and carry out sensitivity teaching periodically.
- This sensor cannot be used in an environment containing inflammable or explosive gases.
- Never disassemble or modify the sensor.
- EEPROM is adopted to this product. It is not possible to conduct teaching 100 thousand times or more, because of the EEPROM's lifetime.

17 INTENDED PRODUCTS FOR CE MARKING

- The models listed under "15 SPECIFICATIONS" come with CE Marking. 
- As for all other models, please contact our office.

Panasonic Electric Works SUNX Co., Ltd.

<http://panasonic-electric-works.net/sunx>

Overseas Sales Division (Head Office)

2431-1 Ushiyama-cho, Kasugai-shi, Aichi, 486-0901, Japan

Phone: +81-568-33-7861 FAX: +81-568-33-8591

Europe Headquarter: Panasonic Electric Works Europe AG

Rudolf-Diesel-Ring 2, D-83607 Holzkirchen, Germany

Phone: +49-8024-648-0

US Headquarter: Panasonic Electric Works Corporation of America

629 Central Avenue New Providence, New Jersey 07974 USA

Phone: +1-908-464-3550

PRINTED IN JAPAN

© Panasonic Electric Works SUNX Co., Ltd. 2010