

Digital Display Pressure Sensor DP-00□(Z)

CMJE-DP0 No.0050-38V

Thank you very much for purchasing Panasonic products. Read this Instruction Manual carefully and thoroughly for the correct and optimum use of this product. Kindly keep this manual in a convenient place for quick reference.

WARNING

- Never use this product as a detection device for personnel protection.
- In case of using devices as detectors for personnel protection, use products which meet laws and standards, such as OSHA, ANSI or IEC etc., for personnel protection applicable in each region or country.
- This product is used for noncorrosive gas. The product shall not be used for liquid or corrosive gas. Never use fluids having inflammability, toxicity, etc., that affect the human body, either.
- A product intended for use in Japan conforms to the Japanese Measurement Act. Do not use a product intended for use overseas in Japan.

1 APPLICABLE STANDARDS / REGULATIONS

- This product complies with the following standards / regulations.
<European Directive>
 EMC Directive



2 PART DESCRIPTION

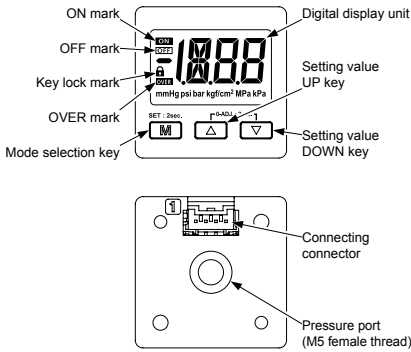

3 PIPING

- When using this product, connect a joint available in the market to the pressure port. At the time, the tightening torque should be 1.0N·m or less.

4 MOUNTING

- Use sensor mounting bracket **MS-DP1-1** prepared independently. When mounting this product with sensor mounting bracket, etc., the tightening torque should be 0.5N·m or less.

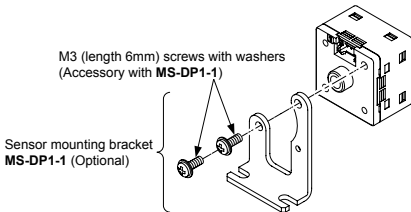

- Panel fittings **MS-DP1-8** (optional) and front cover **MS-DP1-3** (optional) are available.
- For the method for mounting panel fittings, refer to the instruction manual that came with the **MS-DP1-8**.

5 WIRING

How to connect

- Insert the cable with connector **CN-14A-C□** into this product's connection connector section as shown in the right figure.

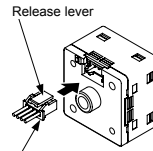

Release lever
 Cable with connector **CN-14A-C□**
<Recommended product>
 Contact: SPHD-001T-P0.5
 Housing: PAP-04V-S
 [Manufactured by JST Mfg. Co., Ltd.]

How to disconnect

- Pressing the release lever of the cable with connector, pull out the connector.

Note: Do not pull by holding the cable without pressing the release lever, as this can cause cable break or connector break.

<Connector pin arrangement>

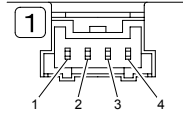

Connector pin No.	Terminal name
1	+V
2	Comparative output
3	No connection (Note)
4	0V

Note: Open or, Connect to 0V.

6 I/O CIRCUIT DIAGRAMS

NPN output type

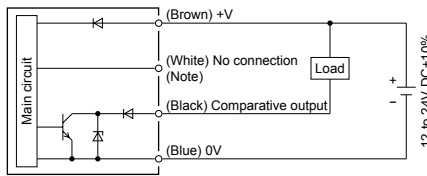

PNP output type

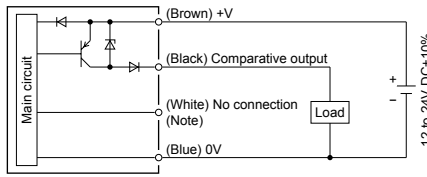

Note: Open or, Connect to 0V.

7 OUTPUT MODE AND OUTPUT OPERATION

- The EASY mode, hysteresis mode or window comparator mode can be selected as the output mode. For details, refer to **<Detailed setting mode>** in **8 Menu setting mode.**

EASY mode

- The comparative output ON / OFF state can be controlled in this mode.

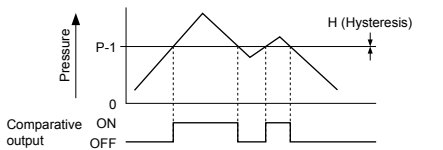

H: Hysteresis fixed (4 digits)
 (10 digits or more when the product is for overseas use and used in units of psi.)

Hysteresis mode

- The comparative output ON / OFF state can be controlled with randomly set hysteresis in this mode.

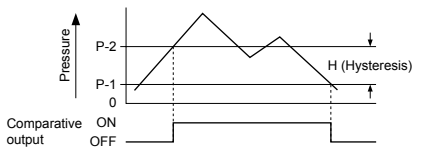

H: 2 digits or more
 (5 digits or more when the product is for overseas use and used in units of psi.)

Window comparator mode

- In this mode, the ON or OFF state of the comparative output is controlled with a pressure in the set range.

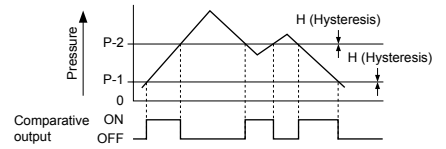

H: Hysteresis fixed (4 digits)
 (10 digits or more when the product is for overseas use and used in units of psi.)

8 MENU SETTING MODE

Display during output operation

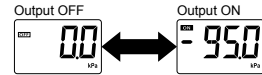

*: Settings of output operation and display colors can be changed in "Display color setting mode" of "Setting mode."

Threshold value setting mode

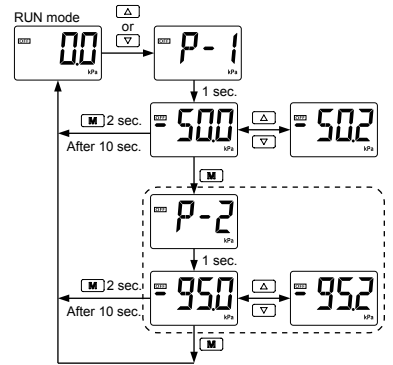

*: Displayed only when hysteresis mode / window comparator mode is set

Zero point adjustment mode

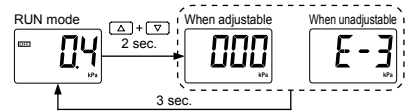

Key lock setting / release mode

<Setting of key lock>

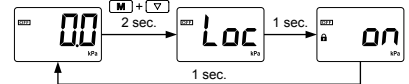

<Release of key lock>

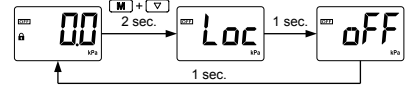

*: The key lock mark appears for 1 sec. when key operation is performed in RUN state with the key lock set (turns OFF in RUN state).

Detailed setting mode

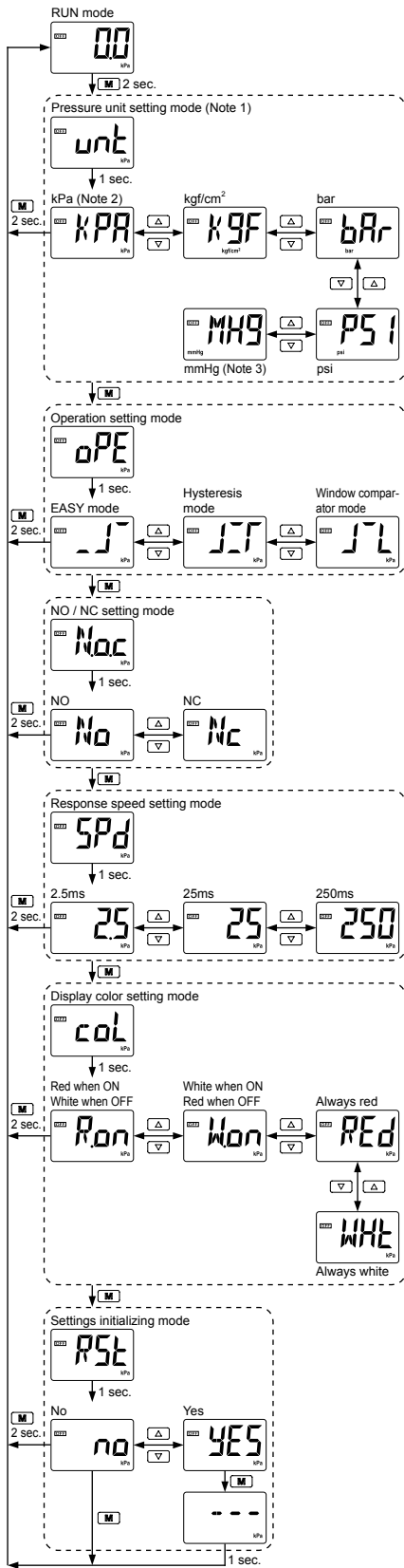

Notes: 1) The pressure unit setting mode is not displayed in the product intended for use in Japan.
 2) "MPa" is used for high pressure type.
 3) "mmHg" is used only for low pressure type.
 4) When setting change has been made, do not turn OFF the power supply within 5 sec. after returning to RUN mode.

9 FACTORY SETTINGS

Type	Low pressure type	High pressure type
Operation setting	EASY mode	
NO / NC setting	NC	NO
Threshold value	-50.0	0.500
Pressure unit	kPa	MPa
Display color	Red when ON, White when OFF	
Response speed	2.5ms	

10 ERROR INDICATION

Error indication	Description	Remedy
E-1	The load is short-circuited causing an overcurrent to flow.	Turn OFF the power and check the load.
E-3	Pressure is applied during zero point adjustment.	Applied pressure at the pressure port should be brought to atmospheric pressure and zero-point adjustment should be done again.
10 10	The applied pressure exceeds the upper limit of the displayed pressure range.	Applied pressure range should be brought within the rated pressure range.
10 10	The applied pressure exceeds the lower limit (back pressure) of the displayed pressure range.	

When other error message is displayed, contact us.

11 SPECIFICATIONS

• Model No.

DP-00 [1] [2] - [3] - [4]

- [1]: 1: Low pressure type, 2: High pressure type
- [2]: None: For outside of Japan, Z: For inside of Japan
- [3]: None: NPN output type, P: PNP output type
- [4]: None: With attachment, J: Without attachment

Type	Low pressure type	High pressure type
Pressure type	Gauge pressure	
Rated pressure range	-100.0 to +100.0kPa	0.000 to +1.000MPa
Displayable / settable pressure range	-101.0 to +101.0kPa	-0.010 to +1.010MPa
Pressure resistance	500kPa	1.5MPa
Applicable fluid	Air, Non-corrosive gas	
Supply voltage	12 to 24V DC ±10% Ripple P-P 10% or less	
Current consumption	30mA or less	
Comparative output	<NPN output type> NPN open-collector transistor • Maximum sink current: 50mA • Applied voltage: 30V DC or less (between comparative output and 0V) • Residual voltage: 2V or less (at 50mA sink current)	<PNP output type> PNP open-collector transistor • Maximum source current: 50mA • Applied voltage: 30V DC or less (between comparative output and +V) • Residual voltage: 2V or less (at 50mA source current)
Output operation	Selectable either NO or NC, with key operation	
Hysteresis	Refer to "12 OUTPUT MODE AND OUTPUT OPERATION"	
Repeatability	±0.2% F.S. (within ±4 digits)	±0.4% F.S. (within ±4 digits)
Response time	2.5ms / 25ms / 250ms Selected by key operation	
Protection	IP40 (IEC)	
Ambient temperature	0 to +50°C (No dew condensation) Storage: -10 to +60°C	
Ambient humidity	35 to 85% RH, Storage: 35 to 85% RH	
Pollution degree	2	
Overvoltage category	I	
Usable altitude	2,000m or less	
Temperature characteristics (+20°C standard)	+10 to +40°C: Within ±1% F.S. 0 to +50°C: Within ±2.5% F.S.	+10 to +40°C: Within ±2% F.S. 0 to +50°C: Within ±5% F.S.
Material	Enclosure: PBT, LCD display: Acryl Pressure port: Brass-nickel plating Mounting screw section: Brass, O-ring: Nitrile rubber (NBR) Key section: Polycarbonate	
Weight (Main body only)	Approx. 25g	
Accessory	CN-14A-C2 (Cable with a connector, 2m long) (optional for J type): 1 pc.	

12 CAUTIONS

- This product has been developed / produced for industrial use only.
- The product shall be used only within the rated pressure range.
- Do not apply pressure exceeding the pressure resistance. Otherwise, destruction of diaphragm occurs, preventing the product to perform normal operation.
- Make sure that the power supply is OFF while performing the wiring operation.
- Verify that the supply voltage variation is within the rating.
- If power is supplied from a commercial switching regulator, ensure that the frame ground (F.G.) terminal of the power supply is connected to an actual ground.
- In case noise generating equipment (switching regulator, inverter motor, etc.) is used in the vicinity of this product, connect the frame ground (F.G.) terminal of the equipment to an actual ground.
- Do not use during the initial transient time (0.5 sec.) after the power supply is switched ON.
- When extending the cable, use a cable whose conductor cross-sectional area is 0.3mm² or more. The cable can be extended to up to 10m in total length.
- Do not run the wires together with high-voltage lines or power lines or put them in the same raceway. This can cause malfunction due to induction.
- The specification may not be satisfied in a strong magnetic field.
- This product is suitable for indoor use only.
- Take care that an excessive stress is not applied to the unit. Otherwise, pressure values may vary.
- Take care that strong impact such as fall is not given to this product. Otherwise, it may be destroyed.
- Avoid dust, dirt, and steam.
- When cleaning, wipe off with a soft cloth that does not make dirt.
- Take care that the product does not come into contact with organic solvents such as thinner.
- Take care that the product does not come into contact with oil or grease.
- Take care that the product does not come into contact with strong acid or alkaline.
- Do not insert wire into the pressure port. Otherwise, destruction of diaphragm occurs, preventing the product to perform normal operation.
- Make sure that stress by forcible bend or pulling is not applied to the sensor cable joint.
- Never disassemble or modify the product.

Panasonic Industrial Devices SUNX Co., Ltd.

http://panasonic.net/id/pidsx/global

Overseas Sales Division (Head Office)

2431-1 Ushiyama-cho, Kasugai-shi, Aichi, 486-0901, Japan

Phone: +81-568-33-7861 FAX: +81-568-33-8591

For sales network, please visit our website.

© Panasonic Industrial Devices SUNX Co., Ltd. 2015
 PRINTED IN JAPAN