

Technical guide

“ZNR” surge absorbers Chip type multilayer varistor

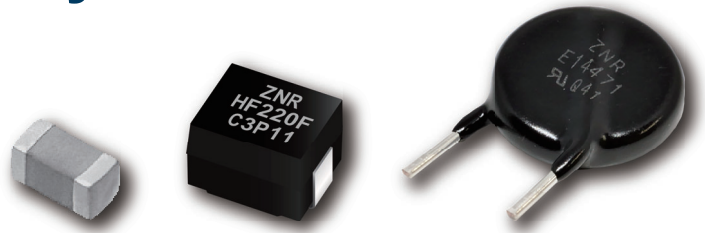

**IN Your
Innovation**



“ZNR” Surge Absorber

Technical guide

| | |
|--|----|
| 1. <u>What Is ZNR?</u> | 1 |
| 1-1. What Is ZNR? | 1 |
| 1-2. Basic characteristics of the varistor | 1 |
| 2. <u>Types of varistors</u> | 2 |
| 2-1. Zener-diode | 3 |
| 2-2. Zinc-oxide varistor | 3 |
| 2-3. Gap-type surge protective device | 3 |
| 2-4. Other varistors | 3 |
| 3. <u>ZNR Applications</u> | 4 |
| 3-1. Absorbing a surge voltage | 4 |
| 3-2. Classification of abnormal voltage types and varistors used as countermeasures against them | 4 |
| 4. <u>Internal microstructure of the ZNR</u> | 5 |
| 4-1. Microscopic image of the “ZNR” | 5 |
| 4-2. Microstructure of the ZNR | 5 |
| 4-3. Electric characteristics of the crystal grain and grain boundary layer | 6 |
| 5. <u>Surge voltage</u> | 7 |
| 5-1. What is a surge voltage? | 7 |
| 5-2. Surge voltage caused by lightning | 7 |
| 5-3. Surge voltage caused by switching | 9 |
| 5-4. Surge voltage generated by static discharge | 9 |
| 5-5. Load dump surge | 9 |
| 6. <u>Explanation of technical terms</u> | 10 |
| 6-1. Varistor voltage | 10 |
| 6-2. Maximum allowable circuit voltage | 10 |
| 6-3. Clamping voltage | 11 |
| 6-4. Surge current withstand | 11 |
| 6-5. Surge energy withstand | 11 |
| 6-6. Rated Power | 11 |
| 7. <u>Selecting ZNR model based on part numbers</u> | 12 |
| 7-1. Selecting a ZNR-D type | 12 |
| (1) Determining the varistor voltage | |
| (2) Determining a series model (∅) | |
| 7-2. Selecting a multilayer varistors | 14 |
| 8. <u>Profile of ZNR</u> | 15 |
| 8-1. Major product models and their features | 15 |
| 8-2. Part number notation on major products | 17 |
| 9. <u>Transient / Surge voltage protection using ZNR</u> | 18 |
| 9-1. Power supply line protection against lightning surge | 18 |
| 9-2. Switching surge protection | 19 |
| 9-3. ZNR selection flowchart | 20 |
| 9-4. Typical ZNR selection flowchart | 21 |
| (1) Protective measures against surges in power lines | |
| (2) Protective measures against switching surges from relays | |
| (3) ZNR selection according to surge test standards | |

1-1. What is ZNR?

ZNR (registered trademark) stands for Zinc-Oxide Non-linear Resistor. It is the name of an epoch-making voltage-dependent resistor that was developed in 1968 by Panasonic Corporation (former Matsushita Electric Industrial). The product itself is generally called a zinc-oxide varistor.

1-2. Basic characteristics of the varistor

When an ordinary resistor R, a DC power supply (source voltage E), and a DC ammeter are connected in series to form a circuit, the current I flowing through this circuit is given by the following equation.

$$I \text{ (current)} = \frac{E \text{ (Power-supply voltage)}}{R \text{ (Resistance value)}} \dots \dots \textcircled{1}$$

The current I is proportional to the applied voltage E but is inversely proportional to the resistance value of the resistor R (Ohm's law).

Let's put this current-voltage relationship on a graph, where the vertical axis (Y-axis) represents current and the horizontal axis (X-axis) represents voltage. When the voltage E is increased from 0 V and the resulting current I is plotted on the graph, a straight line representing the current, appears on the graph Fig. 1.2.

The resistance value of an ordinary resistor is not changed by the voltage applied thereto.

Now take a look at test circuit (B) shown in Fig. 1.3, where the resistor R is replaced with a ZNR (varistor). When voltage E is increased gradually from 0 V and the resulting current flow is plotted on a graph, the current I appearing on the graph is completely different from the straight line that is plotted with the circuit using an ordinary resistor. (see Fig. 1.4)

- ① When voltage E is increased gradually from 0 V, little current I flows until voltage E reaches a given voltage value.
- ② However, at the point voltage E exceeds the given voltage value, the current I starts increasing exponentially.

This happens because of the basic characteristics of the varistor.

The relationship between the voltage E and the current I is determined by the varistor, which is different from the one determined by the ordinary resistor, and is expressed as a curve, as shown in Fig. 1.4 (Voltage-current characteristics of the varistor), and is given by the following equation (2).

$$I = \left(\frac{E}{C}\right)^\alpha \dots \dots \textcircled{2}$$

I : Current flowing through the varistor
 E : The inter-terminal voltage of the varistor
 C : Material-dependent constant
 α : Voltage non-linear coefficient ($\alpha > 1$)

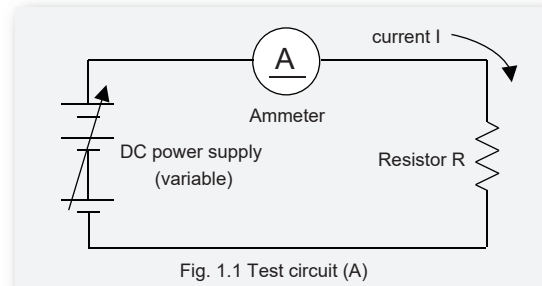

Fig. 1.1 Test circuit (A)

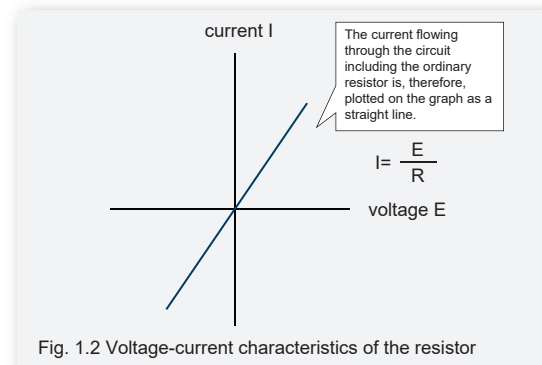

Fig. 1.2 Voltage-current characteristics of the resistor

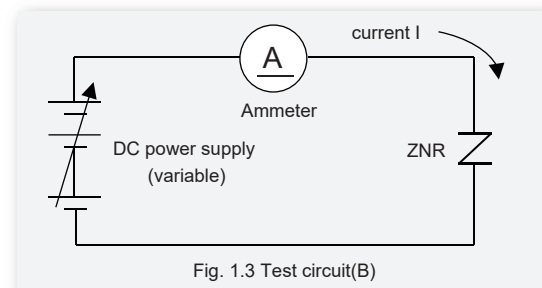

Fig. 1.3 Test circuit (B)

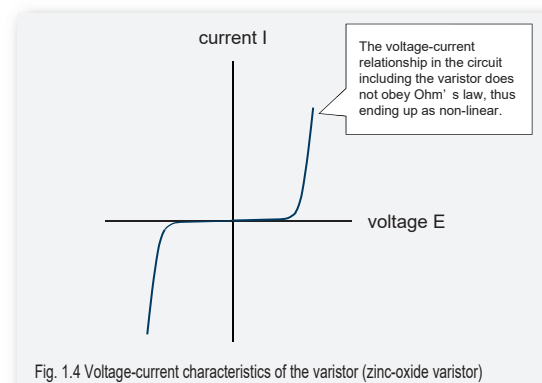
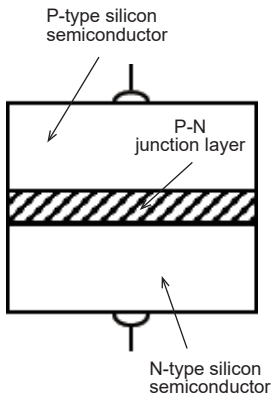
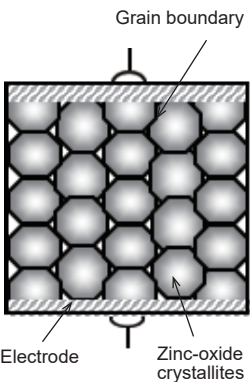
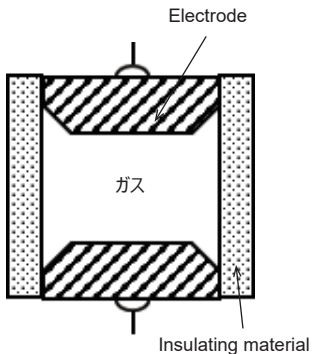
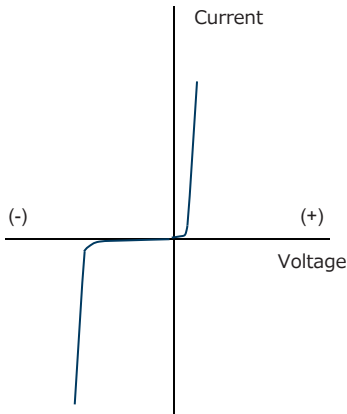
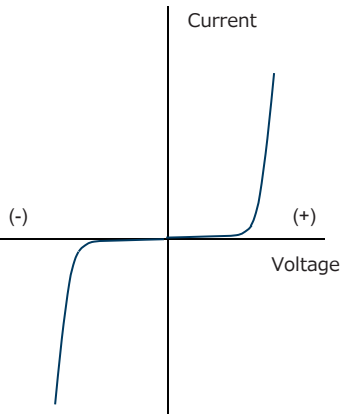
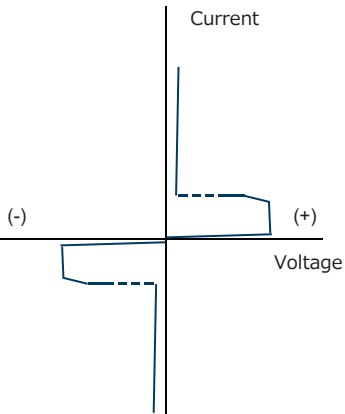

Fig. 1.4 Voltage-current characteristics of the varistor (zinc-oxide varistor)

2 Types of Varistors

A Zener-diode, a zinc-oxide varistor (as a Panasonic product, is called a "ZNR surge absorber"), and a gap-type surge protective device (SPD), which is used for protection against current surges as the varistor is, are typical among a variety of types of varistors. Their structures, operating principles, and characteristics (voltage-current characteristics) are described in the following table.

| | Zener-diode | Zinc-oxide varistor | Gap-type surge protective device |
|----------------------------------|---|---|--|
| Structure operating principle |  <p>The product utilizes the voltage non-linearity of the P-N junction made of silicon single crystals.</p> |  <p>Voltage non-linearity in the grain boundary between zinc-oxide grains is utilized.</p> |  <p>A rise in voltage across the electrodes results in arc discharge, which causes current to flow through the gap.</p> |
| Voltage-current characteristics |  <p>Voltage-current characteristics: Asymmetrical Rise of current is sharp (voltage non-linear exponent $\alpha=30$ to 70)</p> |  <p>Voltage-current characteristics: Symmetric Rise of current is sharp (voltage non-linear exponent $\alpha=20$ to 50)</p> |  <p>Voltage-current characteristics: Symmetric Discontinuous characteristics due to discharge phenomenon. Follow-On Current (Holdover): There is sufficient voltage on the line to keep current flowing, the surge ends and remains in discharge.</p> |

Reference Glossary

- ZNR
⇒ Zinc-oxide non-linear resistor: "ZNR" is a Panasonic's registered trademark.
- Variable Resistor
⇒ Varistor
- Voltage Dependent Resistor
⇒ VDR
- Metal Oxide Varistor
⇒ MOV: Calling metal oxide varistors MOV is more popular, especially in the North American and European regions.
- SPD: Surge protective device, lightning arrester
- TVS: Transient voltage suppressor

2-1. Zener-diode

Si Zener-diode utilizes the voltage non-linearity of the P-N junction made of Si single crystals. Its voltage-current characteristics are expressed as a horizontally asymmetrical curve that is asymmetrical with respect to the Y-axis (which represents current). A voltage applied to the diode in the forward direction causes a current to rise at around 0.6 V to 0.8 V. A voltage applied in the reverse direction has a rise in voltage (Zener voltage), however, it needs to be higher anywhere from several V to 100 V, for the diode yields to allow the current to start flowing. The Zener-diode shows its voltage-current characteristics in the form of a very sharp curve (with voltage non-linearity exponent $\alpha=30$ to 70). Its Zener voltage can be controlled by adjusting the thickness of the P-N junction and an impurity concentration.

2-2. Zinc-oxide varistor

A zinc-oxide (ZnO) varistor is a zinc-oxide ceramic sintered material, in which ZnO crystallite grains are surrounded by a high-resistance layer, such as bismuth oxide (Bi_2O_3) functioning as a grain boundary layer, with a number of ZnO crystallite grains connected across this grain boundary layer.

The zinc-oxide (ZnO) varistor features voltage non-linearity resulting from the ZnO crystallite grains and a high-resistance grain boundary. Its voltage-current characteristics are expressed as a horizontally symmetrical curve that is symmetrical with respect to the Y-axis (which represents current) and that is as sharp as the characteristics curve of the Si Zener-diode, showing a voltage non-linearity exponent of $\alpha=20$ to 50).

Its varistor voltage can be controlled by adjusting the size of ZnO crystallite grains, the thickness of the grain boundary layer, the number of grain connections, etc., using ceramic-based means. For example, the varistor voltage may vary widely to range from several volts to several kilovolts.

Panasonic's ZNR surge absorbers and chip laminated varistors are classified as zinc-oxide varistors.

2-3. Gap-type surge protective device (SPD/Surge Protective Device)

A gap-type surge protective device offers its voltage-current characteristics using a discharge phenomenon. In general, the product has a pair of discharge electrodes placed in an inert gas atmosphere, which gives it its other name "gas discharge tube (GDT)."

(Delay response)

When a surge voltage applied across the discharge electrodes causes them to discharge, it reduces the resistance between the electrodes to create a short-circuited state. As a result, the surge voltage diminishes. It takes a while for the applied surge voltage to trigger discharge.

When the device is connected to a power supply, the device, which is kept supplied with power after absorbing a surge, may continue discharging to maintain a short circuit current flow (Follow on current). When the gap-type SPD is used for protection against power fluctuations of a power supply, a follow-up current prevention measure, such as connecting the SPD in series to a varistor, needs to be taken.

For this reason, the gap-type SPD is rarely connected singly between lines on the primary side of a power circuit. In many cases, the SPD is connected in a series to a varistor, interposed between a line and the ground. In the section between a line and the ground, there may be cases where (because of the influence of ground resistance) a current fuse may not blow when the varistor fails (short circuit), leading to smoking or ignition of the resin covering the varistor. To prevent such an accident, a set of gap-type SPDs and a varistor connected in series are used in some cases.

2-4. Other varistors

There is a varistor composed of a ceramic sintered material made mainly of strontium titanate and barium titanate. It has a voltage-current characteristics curve that is horizontally symmetrical, and a varistor voltage ranging from several volts to score volts.

This varistor is a multifunctional varistor having a large capacitance (capacitor function) in parallel. Working effectively in absorbing clock noises and high-speed pulses generated by digital equipment, it is recognized as a promising varistor that offers many applications.

EZJS series, a Panasonic chip laminated varistor, is classified as this type of varistor.

Reference

The voltage-current characteristics of the varistor (voltage-dependent resistor) are expressed in general by the following equation (1).

$$I = \left(\frac{E}{C} \right)^\alpha \cdot \dots \cdot (1)$$

I : Current flowing through the varistor
 E : The inter-terminal voltage of the varistor
 C : Material-dependent constant
 α : Voltage non-linearity ($\alpha > 1$)

When inter-terminal voltages of the varistor that correspond respectively to measured currents I_1 and I_2 are denoted as V_1 and V_2 , the voltage non-linearity coefficient α of the varistor is given by the following equation (2).

$$\alpha = \frac{\log I_1 - \log I_2}{\log V_1 - \log V_2} = \frac{\log \left(\frac{I_1}{I_2} \right)}{\log \left(\frac{V_1}{V_2} \right)} \cdot \dots \cdot (2)$$

When $I_1/I_2=10$ holds, the voltage non-linearity coefficient α is given by the following equation (3).

$$\alpha = \frac{1}{\log \left(\frac{V_1}{V_2} \right)} \cdot \dots \cdot (3)$$

The equation indicates that the voltage non-linearity exponent α is larger than 1 and that the larger the value of α is, the greater the varistor effects become.

(The greater varistor effects mean a sharper rise in the voltage-current characteristics curve.)

The silicon Zener-diode shows the voltage non-linearity coefficient α ranging from 30 to 70, while the zinc-oxide varistor shows a range from 20 to 50.

3-1. Absorbing a surge voltage

An electronic device using transistors, ICs, etc., is very sensitive to lightning (induction lightning), power switching noise, surge voltages generated by static discharge, etc. (instantaneous high voltages that last for about $1/100(1 \times 10^{-2})$ sec. to $1/100$ million (1×10^{-6}) sec., i.e., score milliseconds to score nanoseconds). When exposed to such noise or surge voltages, the device malfunctions or sometimes gets broken.

The ZNR, with its specific characteristics, instantaneously absorbs such destructive surge voltages, thereby protecting the electronic device. When the ZNR is used for such a purpose, the proper varistor voltage should be selected so that the varistor is kept from operating in ordinary situations but works effectively when a surge voltage intrudes into the device. Metaphorically speaking, the varistor works as a security guard who takes care of an incoming abnormal voltage.

Many ZNR are incorporated in transmission lines carrying electricity as well as in-office equipment, communication devices, household appliances, and automobiles using transistors, ICs, etc.

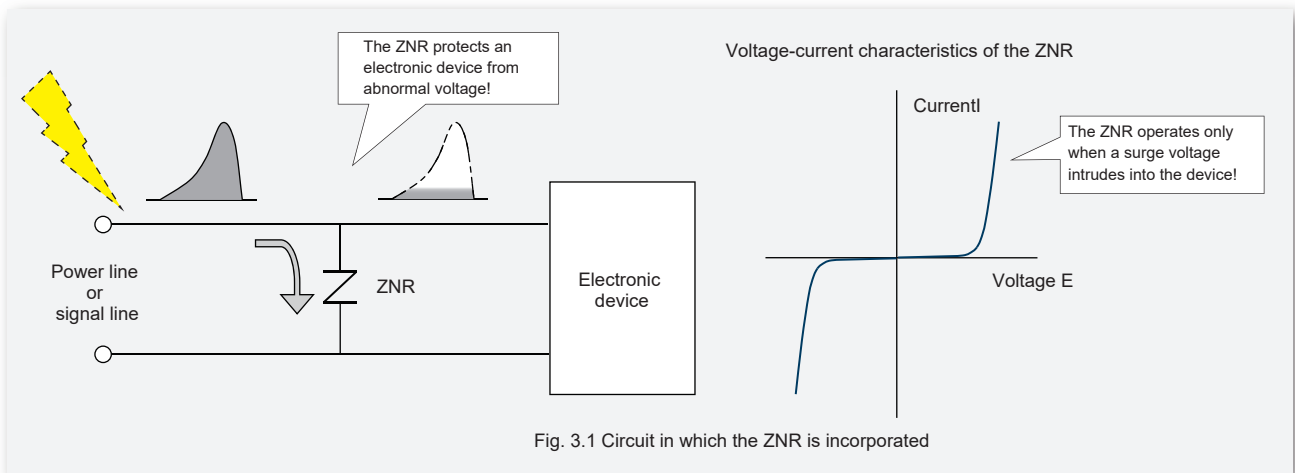
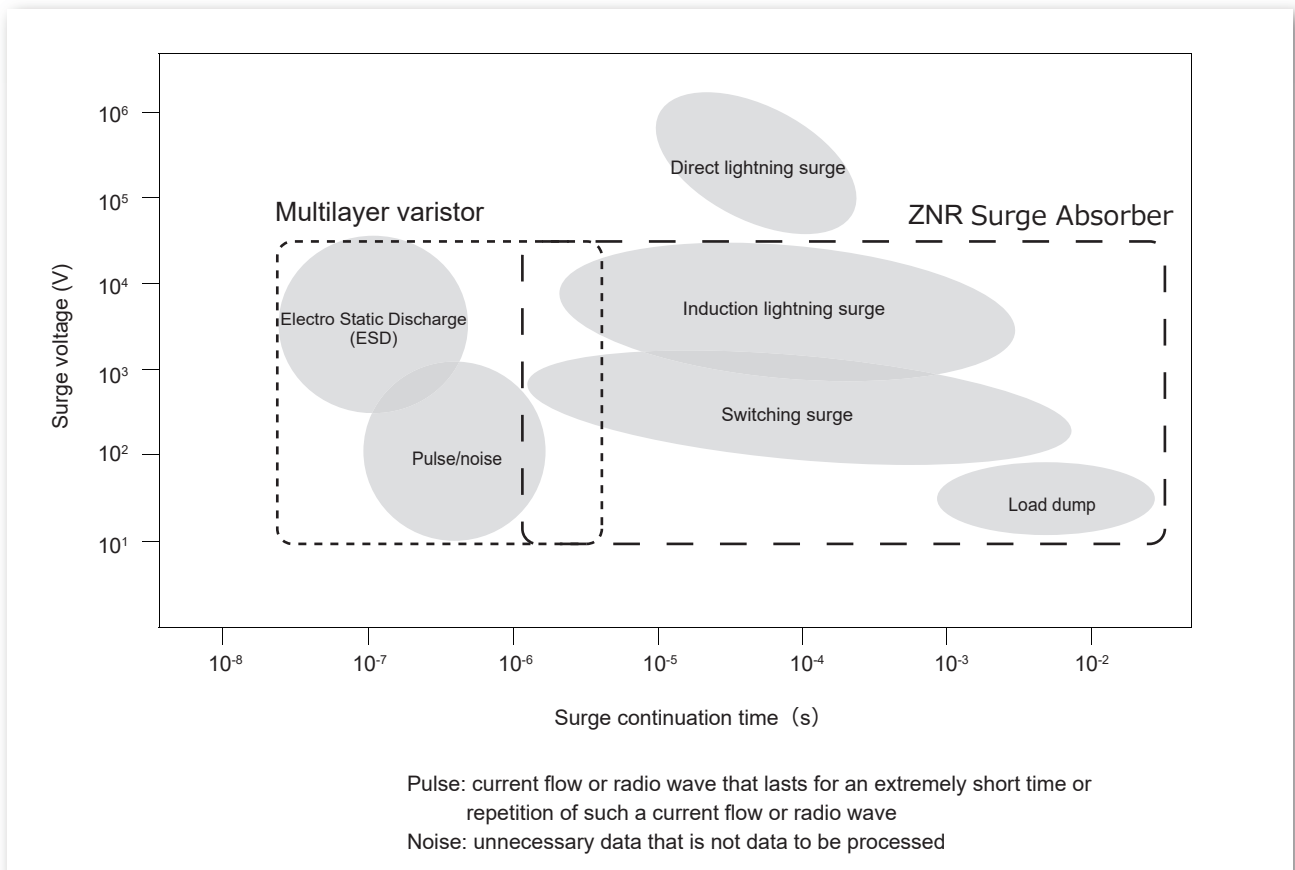

Fig. 3.1 Circuit in which the ZNR is incorporated

3-2. Classification of abnormal voltage types and varistors used as countermeasures against them



4-1. Microscopic image of the “ZNR”

ZNR is ceramic sintered compact, fabricated by adding a small amount of an additive, such as bismuth oxide (Bi_2O_3), to the main material, zinc oxide (ZnO), mixing, crushing, and granulating the material into powder, compacting the powder, and then baking the compacted powder at high temperature.

This ceramic sintered compact or ceramic sintered material looks the same as ordinary ceramic products (porcelain, chinaware, etc.) as far as its external appearance is concerned.

However, observing the surface of the ZNR with an electron microscope reveals that numerous crystal grains with a uniform grain diameter, aggregate to form a stone-wall-like structure, as shown in photo 4.1.

The ceramic structure of the ZNR is composed of numerous zinc-oxide (ZnO) crystal grains and grain boundary layers (layers formed between adjacent crystal grains) surrounding the crystal grains. A diagrammatic expression of this structure is shown in Fig. 4.1.

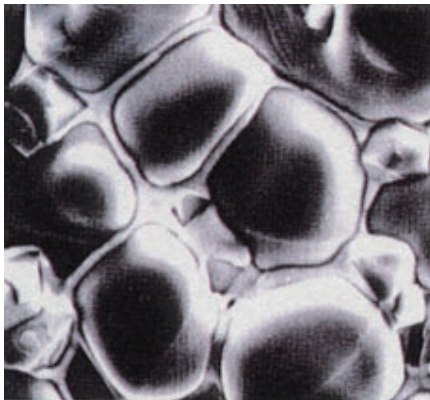

Photo 4.1 Microscopic image of the ZNR (example)

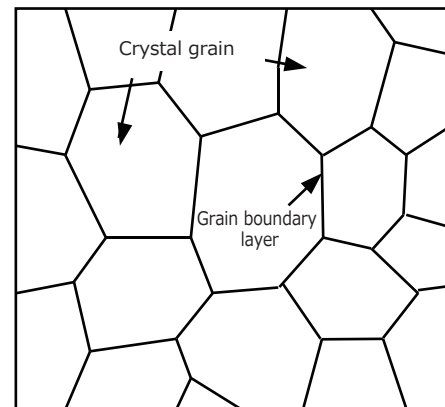

Figure 4.1 Structural model of polycrystalline aggregates

4-2. Microstructure of the “ZNR”

Analyzing the grain boundary layers that are shown in 4-1 in detail, using an X-ray microanalyzer, reveals that bismuth oxide (Bi_2O_3) has densely crystallized in the grain boundary layers between adjacent crystal grains, as shown in photo 4.2.

White areas observed in photo 4.2 are heavy concentrations of bismuth oxide.

In this manner, these grain boundary layers are composed mainly of bismuth oxide and surround individual zinc-oxide crystal grains.

Now, applying a special etching solution to this ceramic sintered material melts only the ZnO crystal grains away while leaving the grain boundary layers intact. Observing the remaining grain boundary layers with an electron microscope reveals that the skeleton of the grain boundary layers made of bismuth oxide forms a continuous, solid structure similar to a jungle gym found in an amusement park, etc.

ZNR thus has a structure in which "a ZnO crystal grain and a bismuth oxide grain boundary layer surrounding the crystal grain form a unit, and a number of such units are connected in a solid and meshed pattern."

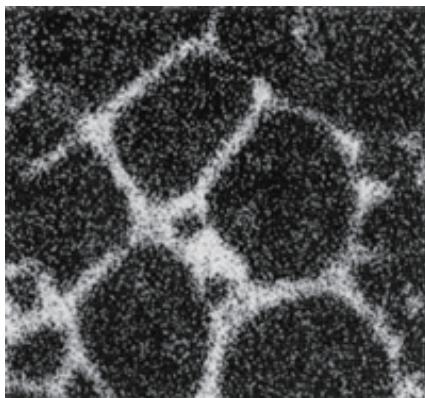

Photo 4.2

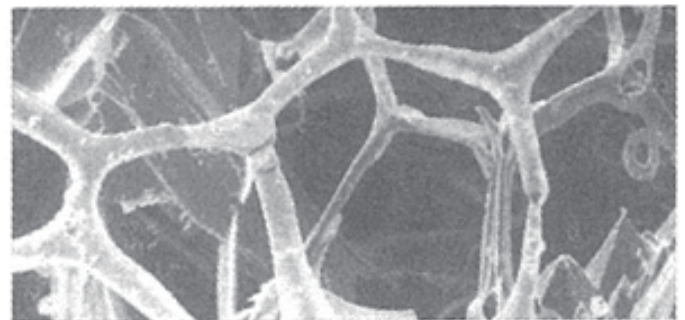

Photo 4.3

4-3. Electric characteristics of the crystal grain and grain boundary layer

This section will discuss the electric characteristics of the crystal grain and grain boundary layer, focusing on the basic unit making up the ceramic sintered material: "ZnO crystal grain - Bi₂O₃ grain boundary layer - ZnO crystal grain."

[Specific resistance of the crystal grain and grain boundary layer]

The specific resistance value of a ZnO crystal grain is $\rho=1$ to $10 \Omega \cdot \text{cm}$, which is very small. In contrast, the specific resistance value of a Bi₂O₃ grain boundary layer surrounding the crystal grain is $\rho=10^{12}$ to $10^{13} \Omega \cdot \text{cm}$, which is incomparably larger.

When a voltage is applied to the basic unit "ZnO crystal grain - Bi₂O₃ grain boundary layer - ZnO crystal grain," most of the voltage concentrates on the Bi₂O₃ grain boundary layer.

To put it in another way, "the electric characteristics are determined by the properties of the Bi₂O₃ grain boundary layer."

(Figs. 4.2)

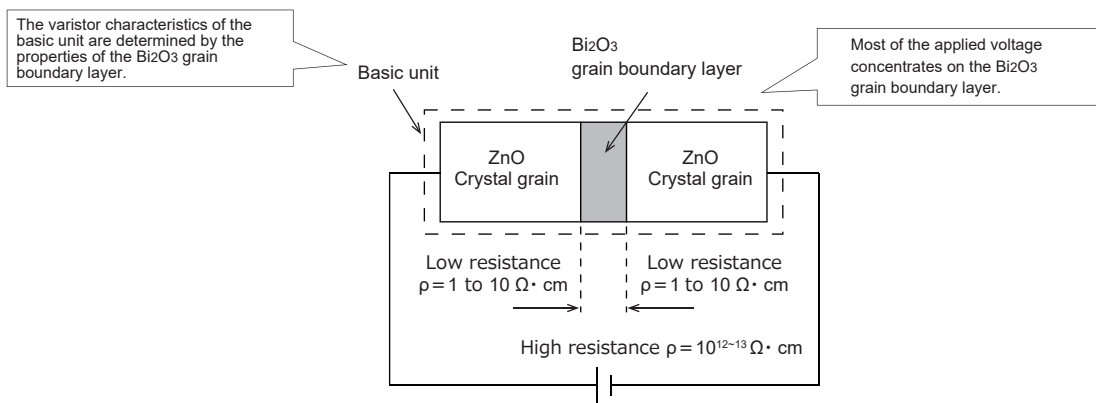

Figs.4.2

[Energy barrier between the crystal grain and the grain boundary layer]

Applying a voltage to the basic unit "ZnO crystal grain - Bi₂O₃ grain boundary layer - ZnO crystal grain" causes a peculiar phenomenon in the basic unit. Please look at the illustrations in Figs. 4.3 and 4.4.

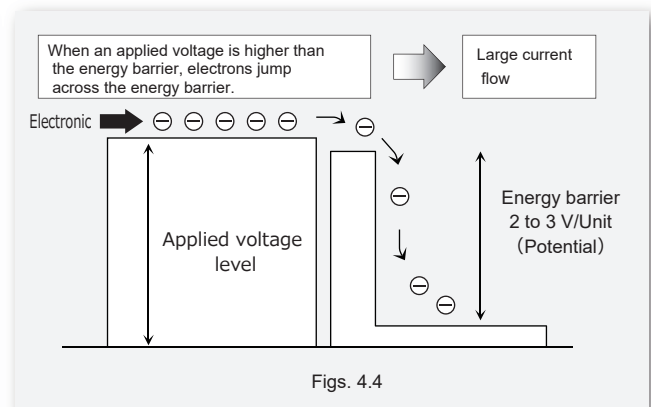
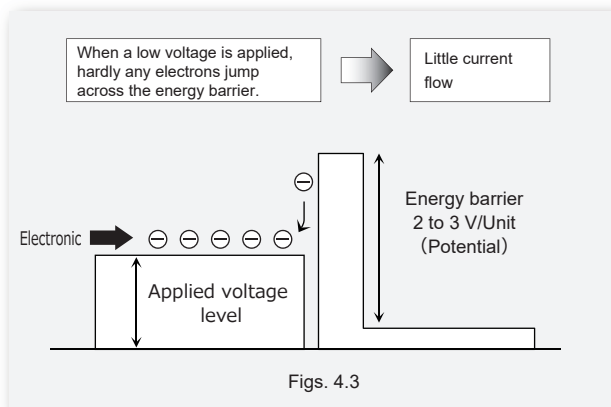

The basic unit has an inherent energy barrier (equivalent to 2 to 3 V) formed between the ZnO crystal grain and the Bi₂O₃ grain boundary layer. Applying a voltage lower than the energy barrier (equivalent to 2 to 3 V) to the basic unit, therefore, yields little current flow. When the applied voltage exceeds the energy barrier, however, a current suddenly starts flowing. This behavior demonstrates the fact that each basic unit works as an independent varistor.

[Symmetrical voltage-current characteristics curve]

Different in structural principle from the Zener-diode having a silicon semiconductor P-N junction, the ZNR has no electrical polarity (which means changing the polarity of an applied voltage does not change the voltage-current characteristics of the varistor). The ZNR thus shows a symmetric voltage-current characteristics curve.

5-1. What is a surge voltage?

"Surge voltage", which stands for "Transient Surge Voltage", has its official name: "transient surge voltage", which refers to "transient and instantaneous abnormal voltage".

A surge voltage is generally defined as "an abnormal voltage that is generated instantaneously as a voltage extremely higher than the steady voltage in electric (electronic) circuits or transmission lines."

A surge voltage generated by various causes propagates through power lines, signal lines, etc., while being reflected or attenuated repeatedly, and intrudes into power/electronic equipment, where the surge voltage causes the equipment to stop, malfunction, deteriorate, or even break. It, therefore, poses a great threat to the reliability of the equipment.

Surge voltages (abnormal voltages) are classified by causes as follows.

- (1) The abnormal voltage between power lines or communication lines caused by lightning
- (2) Abnormal voltage caused by a power supply being switched on and off
(especially, an abnormal voltage generated in an inductive load, such as a coil and a transformer)
- (3) Abnormal voltage caused by static discharge
- (4) Others (abnormal voltage caused by a ground fault, etc.)

5-2. Surge voltage caused by lightning

Lightning causes of surge voltages are classified into direct lightning and induction lightning.

Direct lightning is "a phenomenon where enormous electric energy accumulated in thunderclouds is discharged directly to the ground or power lines." Electrical equipment, devices, etc., connected to lines exposed to lightning discharge are severely damaged by the large energy of direct lightning, resulting in a flashover, destruction of equipment, and the like.

Existing arrestors are not powerful enough to absorb the discharge energy of direct lightning. Common countermeasures against direct lightning include installing lightning conductors and providing power transmission lines with the aerial ground line.

Now induction lightning is a bit complicated. Please see Fig. 5.1. When a thundercloud carrying positive and negative charges approaches a power transmission line, communication line, control signal line, etc., the thundercloud induces high-potential positive charges over the line because of the negative charges the thundercloud carries.

When the accumulating charges reach a certain extent, the thundercloud quits holding the charges, releasing them to a cloud nearby or the ground through the air, whose insulation is broken due to the high potential difference. This results in a sharp decrease in negative charges at the bottom of the thundercloud. As negative charges in the thundercloud diminish, positive charges gathering along the line are released from the attractive force of those negative charges, thus starting to propagate in both directions along the line, as shown in Fig. 5.2. This induction process that leads to the propagation of positive charges is referred to as induction lightning, and a surge voltage generated by the induction lightning is referred to as induction lightning surge voltage or static induction surge voltage.

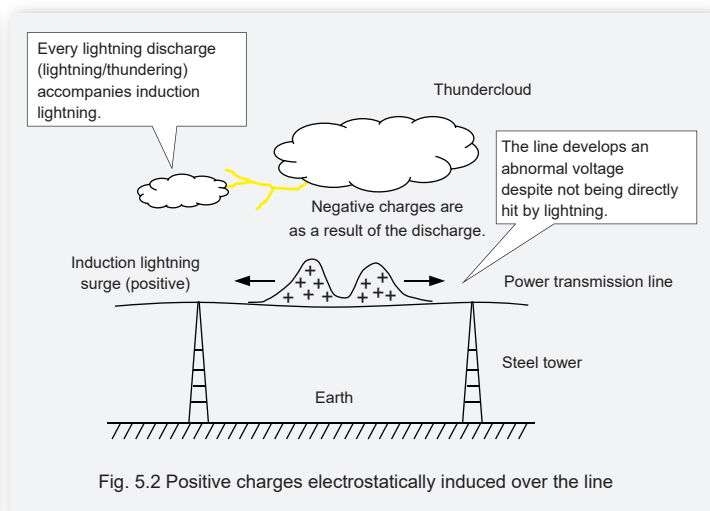
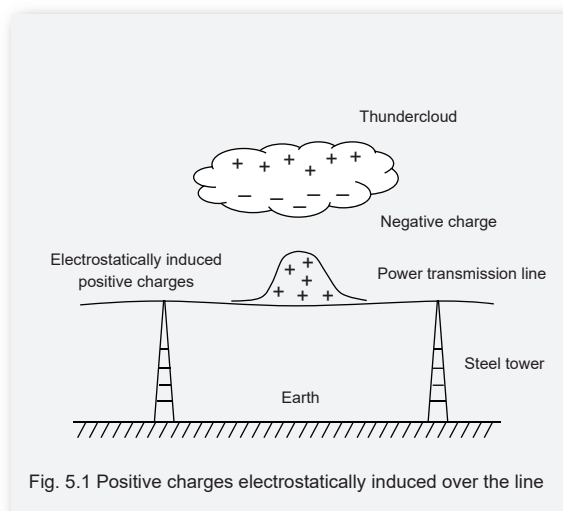

Properties of direct lightning and induction lightning are listed in table 5.1.

| Item | Direct lightning | Direct lightning |
|-------------------------|---|---|
| Voltage peak value | About 5000 kV | 50 kV or lower |
| Current peak value | Higher than several tens of thousands A | 5000 A or lower |
| Surge voltage | Time of wave front : 1 to 7 μ s Time of wave tail : About 40 μ s Wave front steepness : About 270 kV/ μ s | Time of wave front : 1 to 30 μ s (20 to 30 μ s in many cases) Time of wave tail : 40 to 200 μ s Wave front steepness : About 5 kV/ μ s |
| Polarity | Usually negative (single polarity) | Usually positive (single polarity) |
| Surge energy | Surge energy is so large as to cause a flashover of all electrical equipment insulators. Protective devices :Lightning conductors, aerial ground lines (Surge absorbers cannot absorb the large surge energy of direct lightning.) | Surge energy is not so large and rarely causes flashover. Protective devices : Surge absorbers can absorb the surge energy of induction lightning. |
| Frequency of occurrence | Low | High |
| Other | Direct lightning occurs frequently in summer (It, however, may occur in winter as well.) Direct lightning causes damage to | Direct lightning occurs frequently in summer (It, however, may occur in |

Table 5.1 Properties of direct lightning and induction lightning

Test methods and conditions concerning lightning surges are defined in IEC61000-4-5 (international standards).

Equipment manufacturers and parts manufacturers conduct surge tests in various places, using surge testing machines conforming to the standards, to check the effectiveness of varistors and certify equipment.

5-3. Surge voltage caused by switching

When an induction load, such as a transistor and a coil, is connected to a power circuit and a switch on the circuit is turned on and off, a surge voltage appears at both ends of the load.

This happens in the following manner. At the moment of opening/closing the circuit by flipping the switch on/off, electromagnetic energy expressed as $\frac{1}{2} \times L \times i^2$ is left in the induction load connected to the circuit (see Fig. 5.3), and this energy is not held steadily in the load but appears at both ends in the form of surge voltage (Fig. 5.4).

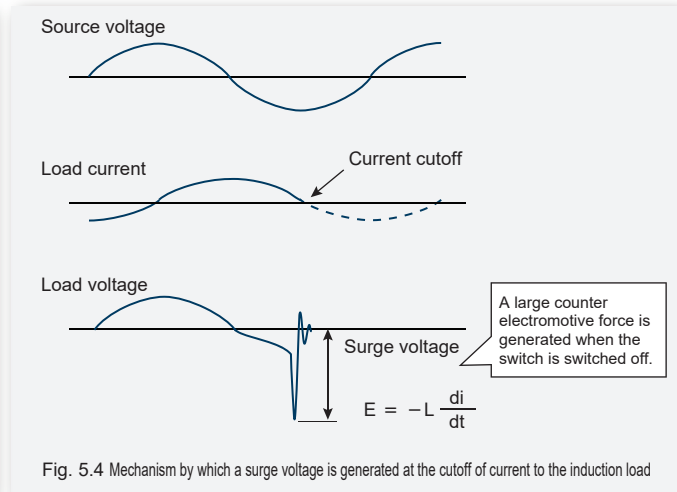
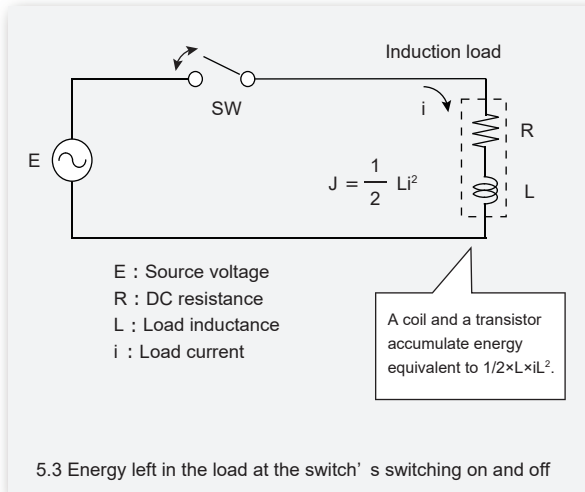

This surge voltage is called counter electromotive force, which is given by the following equation ①.

$$E \text{ (Counter electromotive force)} = -L \frac{di}{dt} \cdot \cdot \cdot \text{①}$$

L : Inductance
i : Current
t : Time

Counter electromotive force E is proportional to the inductance (H or Henry) of the induction load and becomes greater as di/dt, i.e., a current cutoff rate (switching speed) gets higher.

The value of di/dt is large when a switch with excellent inter-electrode insulation recovery characteristics, such as a vacuum switch, or a switch with a contact material showing a large interrupting current value is used, in which case a large counter electromotive force is created.

A microswitch, a vacuum switch, a lead switch, a current-limiting fuse, etc., shows a high current cutoff rate, and therefore, by switching on/off, generates a large counter electromotive force.

5-4. Surge voltage generated by static discharge

There are various forms of static discharge, such as charges being released from antennas into video equipment and static electricity accumulated in human bodies being discharged into circuit elements. One thing that is characteristic of static discharge is a very high voltage peak value. (Energy involved in static discharge, however, is not so high.)

Standards for static electricity tests include IEC 61000-4-2, IEC 61340-3, and ISO 10605 (international standards). Equipment certification tests and varistor effectiveness checks are carried out, using testing machines conforming to these standards.

5-5. Load dump surge

This is a surge that arises when a battery terminal of a car comes off (disconnection, current cutoff).

When an alternator (battery-charging generator) charges a battery by feeding it with current through a power line, a surge voltage arises, if the battery is disconnected from the power line. Carrying a large amount of energy, this surge voltage often goes up beyond 100 V and lasts for several hundred milliseconds, thus destroying various electronic components making up an ECU.

Standards for load dump tests include JASO A-1 (Japan) and ISO 7637-2 Pulse 5/ISO 16750-2 Test A (international standards). Equipment certification tests and varistor effectiveness checks are carried out, using surge testing machines conforming to these standards.

The following table is an excerpt from a catalog of the ZNR-D type.

| Part No. | Varistor voltage | | Maximum allowable voltage | | Clamping voltage (max.) **I _p | Rated power (W) | Maximum energy | | Maximum peak current (8/20 μs) | | Capacitance (max.) at 1 kHz (pF) |
|------------|-------------------------|--------------|---------------------------|-----|---|-----------------|------------------|------------|--------------------------------|-------------|----------------------------------|
| | V _{0.1 mA} (V) | AC rms (V) | DC (V) | (V) | | | (10/1000 μs) (J) | (2 ms) (J) | 1 time (A) | 2 times (A) | |
| | ERZV05D820 | 82(74 to 90) | 50 | 65 | 145 | 0.1 | 3.5 | 2.5 | 800 | 600 | 460 |
| ERZV05D101 | 100(90 to 110) | 60 | 85 | 175 | 0.1 | 4.0 | 3.0 | 800 | 600 | 400 | |
| ERZV05D121 | 120(108 to 132) | 75 | 100 | 210 | 0.1 | 4.5 | 3.5 | 800 | 600 | 350 | |

6-1 This represents a rising voltage of V-I characteristics, which are the basic characteristics of the varistor.
 6-2 A maximum allowable circuit voltage is related to the source voltage of the varistor. An incorrect maximum allowable circuit voltage leads to grave consequences.
 6-3 To what voltage level (volt) does the varistor confine a surge voltage?
 6-6 Maximum pulse power the varistor can withstand when supplied with a series of pulse currents over short intervals.
 6-5 How much energy is the varistor able to withstand? The maximum energy the varistor can withstand is listed in terms of joule.
 6-4 What size (ampere) of a surge current is the varistor able to withstand?

6-1. Varistor voltage

The ZNR is a voltage-dependent resistor. It functions as an insulator when an applied voltage is at a given level or lower level. When the applied voltage exceeds the given level, however, the varistor becomes electrically conductive, thus allowing the current to start flowing suddenly. (Fig. 6.1)

Its varistor voltage represents a rising voltage of the voltage-current characteristics curve, that is, a voltage at which the current starts flowing.

Usually, the varistor voltage is measured for a DC 1 mA. To avoid heat generation effects, the varistor voltage is measured as quickly as possible.

(The varistor voltage is measured for a DC 0.1 mA in some cases.)

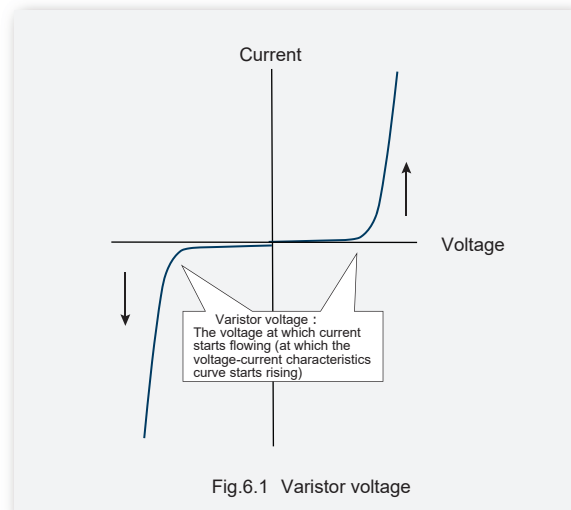

Fig.6.1 Varistor voltage

6-2. Maximum allowable circuit voltage

Maximum allowable circuit voltage refers to the maximum source (circuit) voltage that is allowed to be applied across both ends of the ZNR.

As shown in Fig. 6.2, the ZNR is connected in parallel to an AC or DC power supply.

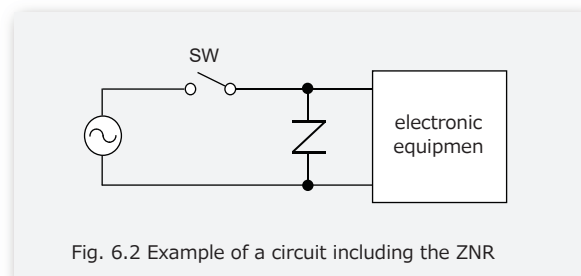

Fig. 6.2 Example of a circuit including the ZNR

In this circuit configuration, it is important that the ZNR does not operate in normal situations but operates when an abnormal voltage intrudes into the circuit. "The ZNR does not operate in a normal situation" means that the varistor voltage should be selected properly so that in a normal situation, the ZNR connected to the power supply hardly allows any current to flow therethrough.

A maximum allowable circuit voltage, which is the maximum effective value (AC rms) of a sine wave AC voltage with a frequency (50 Hz/60 Hz) for commercial use or the maximum for DC voltage, is specified for each product number.

Using the ZNR with a voltage exceeding the maximum allowable circuit voltage may result in the deterioration or burning of the ZNR. It is, therefore, necessary that the source voltage, which includes temporary overvoltage caused by circuit voltage fluctuations, power supply system failure, etc., does not exceed the maximum allowable circuit voltage.

6-3. Clamping voltage

To what voltage level (volt) does the ZNR confine a surge voltage generated by induction lightning, etc., and that is being applied to the ZNR to protect electronic equipment?

A voltage to which the varistor confines a surge voltage is referred to as "Clamping voltage." Fig. 6.3 depicts a standard lightning surge current waveform "8/20 μ s." When a specified current with this waveform flows through the varistor, the resulting maximum voltage is defined as a maximum clamping voltage.

The clamping voltage is determined by a surge current flowing through the ZNR. Maximum clamping voltages for currents other than the specified current can be read from voltage-current characteristics curves (see Fig. 6.4).

It is necessary that a clamping voltage, for the surge voltage assumed to arise, be lower than the surge withstand voltage of the circuit (component) to be protected.

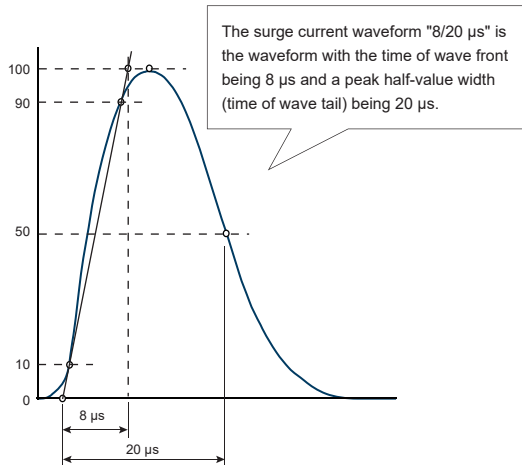

Fig. 6.3 Standard lightning surge current waveform

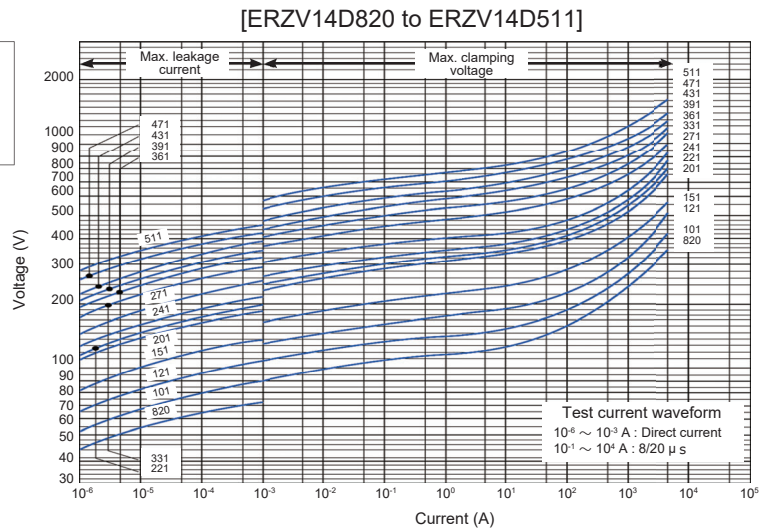

Fig. 6.4 Impulse derating

6-4. Surge current withstand

A surge current withstand refers to the maximum current that the ZNR can withstand (its varistor voltage shows a fluctuation rate of $\pm 10\%$ or less) when exposed to a surge current with the standard lightning surge current waveform of "8/20 μ s."

The first and second pulses of current to be applied to the varistor are specified. Other pulses of current to follow can be read from an impulse derating (see Fig. 6.5).

For example, "8/20 μ s, 10 pulses, 2000 A" means that even when 10 pulses of current of the standard lightning surge current waveform (8/20 μ s) with a peak value of 2000 A are applied in sequence to the varistor, the varistor remains fault-free and is used without a problem (its varistor voltage shows a fluctuation rate of $\pm 10\%$ or less).

Note that there is a requirement that surge current application intervals be determined in such a way as to eliminate heat generation effects.

Measure in the shortest possible time to avoid the effects of heat generation. (It may be measured at 0.1mA)

The magnitude of the surge current withstand depends on the electrode area of the varistor. The larger the electrode diameter, the greater the surge current withstand.

[ERZV14D820 to ERZV14D511]

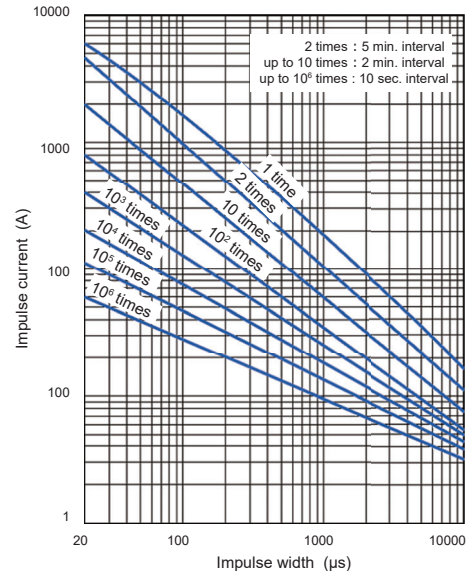

Fig. 6.5 Impulse derating

6-5. Rated power

How much energy the varistor is able to withstand (its varistor voltage shows a fluctuation rate of $\pm 10\%$ or less)? The surge energy withstand is the maximum energy the varistor can withstand and is expressed in terms of joule. The surge energy withstand is defined in the form of impulse waveforms "2 ms (square waveform)" and "10/1000 μ s (attenuated waveform)."

The times of wave tail for individual current waveforms are as follows.
 • 8/20 μ s \rightarrow 20 μ s
 • 2ms \rightarrow 2ms

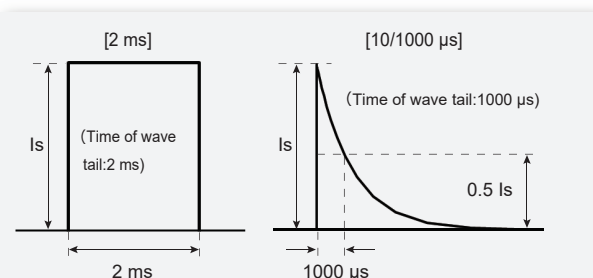

Fig. 6.6 Impulse waveforms

6-6. Maximum average pulse power

This is the maximum pulse power the varistor can withstand (its varistor voltage shows a fluctuation rate of $\pm 10\%$ or less) when supplied with a series of pulse currents over short intervals.

7-1. Selecting a ZNR-D type

(1) Determining the varistor voltage

The varistor voltage is determined from a relationship between the maximum allowable voltage (> used circuit voltage) and the clamping voltage (< the surge withstand voltage of the component to be protected). It is necessary that ZNR specifications, the circuit to be protected, and surge conditions be well coordinated for protection against a surge.

[Examining the lower limit of the varistor voltage]

A surge protection measure carried out by the ZNR requires that no current flows through the ZNR when only the source (circuit) voltage is applied to the ZNR but surge current flows through the ZNR when a surge voltage is applied to the ZNR.

To allow the ZNR to meet this requirement, the source (circuit) voltage, which is a specification item of the ZNR, should never exceed the maximum allowable voltage. Based on this relationship between the source (circuit) voltage and the maximum allowable circuit voltage, the lower limit of the applicable varistor voltage is determined.

Using the ZNR with a source voltage higher than the maximum allowable voltage may lead to the deterioration or burning of the ZNR. It is thus necessary to ensure that the source voltage, including temporary overvoltage caused by circuit voltage fluctuations, power supply system failure, etc., does not exceed the maximum allowable voltage.

[Examining the upper limit of the varistor voltage]

To protect a circuit when a surge is applied to the ZNR, it is necessary that the surge voltage, as a result of a surge current flowing through the ZNR (Clamping voltage), is confined and be lower than the surge withstand voltage of the circuit (component) to be protected. It should be noted that the surge voltage, in general, is a transient voltage that lasts for an extremely short time, e.g., several microseconds (μs) to several milliseconds (ms).

The surge withstand voltage of the circuit (component) is higher than the rated voltage which target circuit or components.

Based on this relationship between the surge voltage and the surge withstand voltage, the upper limit of the applicable varistor voltage is determined.

A coordinated relationship between these ZNR specifications and surge conditions is shown in Fig. 7.1.

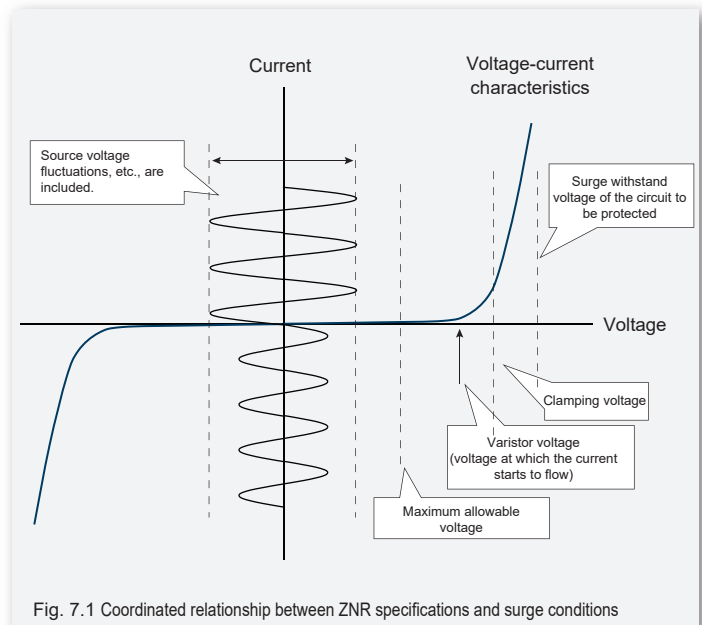

Fig. 7.1 Coordinated relationship between ZNR specifications and surge conditions

[Reading the voltage-current characteristics (V-I characteristics) curve]

The V-I characteristics of the ZNR are highly non-linear and are therefore usually plotted on a double logarithmic chart (see Fig. 7.2).

The V-I characteristics show the characteristics of the lightning surge standard current waveform "8/20 μs " in an area higher than a varistor voltage measurement current (10^{-3} A or 10^{-4} A) and show the characteristics of direct current (DC) with an area lower than the varistor voltage measurement current.

The V-I characteristics shown in catalogs and Web pages indicate the maximum limit voltage in the area higher than the varistor voltage measurement current (10^{-3} A or 10^{-4} A) and a minimum limit voltage in the area below the varistor voltage measurement current so that the maximum clamping voltage and maximum leak current (DC) can be read.

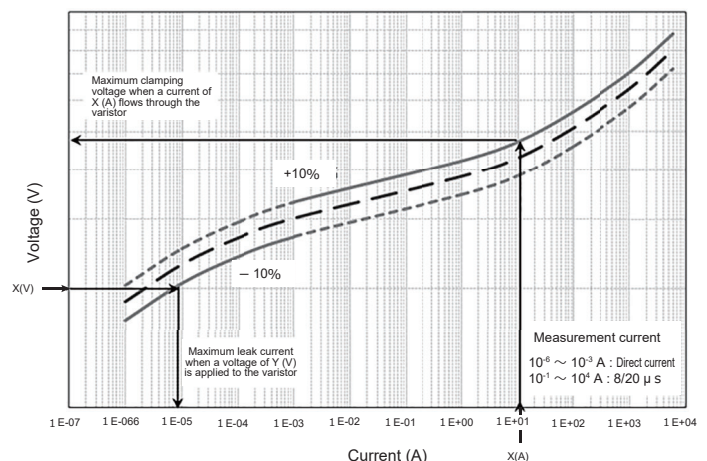

Fig. 7.2 ZNR voltage-current characteristics curve

(2) Determining a series model (ø)

A series model is selected from the viewpoint of its ability to absorb a surge.

A series model with a larger size can handle larger surge energy and multiple surges.

ZNR specifications, such as surge current withstand, are examined so that the ZNR operates without a problem when a surge is applied thereto.

[Surge current withstand]

The surge current withstand specified in the ZNR specifications is the maximum surge current that the ZNR allows to flow through when a standard lightning surge current "8/20 μs" is applied to the ZNR once or twice.

[Surge energy withstand]

Energy defined as the surge energy withstand is calculated from a current value and a limit voltage value in the case of a square wave current (2 ms) or an attenuated wave current (10/1000 μs) being applied to the varistor once.

$$J = K \times I_s \times V_{Is} \times T \quad (J)$$

K : Constant defined for each surge current waveform (see Fig. 7.3)

I_s : Surge current flowing through the ZNR (A)

V_{Is} : Clamping voltage when a surge current (I_s) flows through the ZNR (V)

T : Time of wave tail of a surge current (surge current continuing time) (s)

| Waveforms of the surge current flowing into the ZNR | Surge current waveforms | K |
|---|--|------|
|  | I _s Square wave | 1 |
|  | 8/20μs Lightning surge standard wave | 0.84 |
|  | I _s Exp(-t/1.44T) Attenuated wave | 1.44 |

Fig. 7.3 Constants defined for individual surge current

Ability to absorb a series of surges or surges repeated a number of times

[Impulse derating]

The surge current withstand and the surge energy withstand define the surge current and the energy that the ZNR can withstand, respectively. When surge currents of waveforms and the number of times of applications of surge currents not defined are examined, an impulse derating graph found in catalogs or Web pages is referred to. The graph indicates the relationship between the time of wave tail (surge current continuing time), the surge current value, and the number of times of surge applications the ZNR can withstand (its varistor voltage fluctuation rate is ±10% or lower), providing reference to the examination.

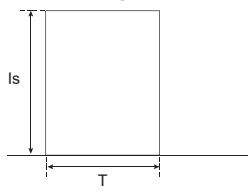
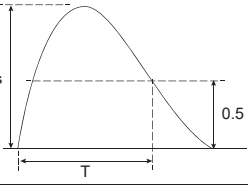
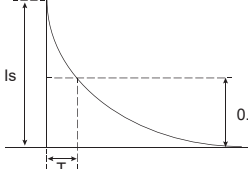
Note that there is a requirement that surge current application intervals be determined in such a way as to eliminate heat generation effects. (see Fig. 7.4)

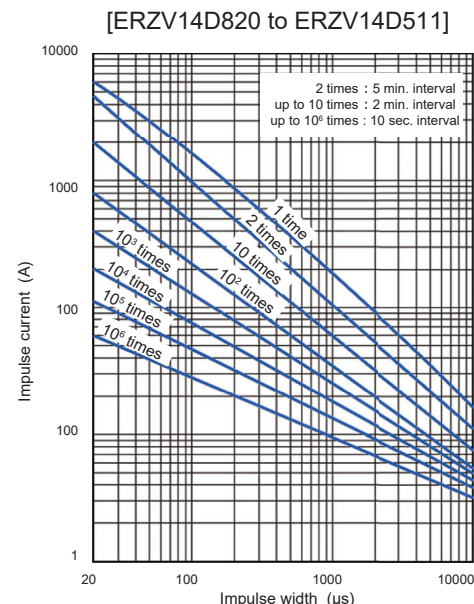

Fig. 7.4 Impulse derating

[Rated power]

The rated power of a series of pulses of surge currents applied over short intervals is examined.

A series model is selected as one that meets a condition that power calculated by the following equation is smaller than the rated power specified in the ZNR specifications.

$$P = J / T_i \quad (W)$$

J : The energy of the pulse of surge current the ZNR withstands (J)

T_i : Surge current application interval (s)

A series model (Φ) that meets the condition "P=J/T_i ≤ maximum average pulse power" should be selected.

7-2. Selecting a multilayer varistor

The following table is an excerpt from a catalog of a multilayer varistor used as a protective measure against electrostatic discharge (ESD).

| Size | Part. No | Maximum allowable voltage | Nominal varistor voltage | Capacitance (pF) [typ. Reference value] | | Maximum peak current at 8/20 μ s, 2 times (A) | Maximum ESD IEC61000-4-2 |
|------|-------------|---------------------------|--------------------------|--|-----------|---|-----------------------------|
| | | DC (V) | at 1 mA (V) | at 1 MHz | at 1 kHz | | |
| 0201 | EZJPZV6R8JA | 3.7 | 6.8 | 220 max. [150 typ.] | 175 typ. | 5 | Contact discharge:8 kV |
| | EZJPZV6R8GA | 3.7 | 6.8 | 100 max. [85 typ.] | 100 typ. | 5 | |
| | EZJPZV080GA | 5.6 | 8 | 100 max. [85 typ.] | 100 typ. | 5 | |
| | EZJPZV120GA | 7.5 | 12 | 100 max. [85 typ.] | 100 typ. | 5 | |
| | EZJPZV120DA | 7.5 | 12 | 27 max. [22 typ.] | 33 typ. | 1 | |
| | EZJPZV120RA | 7.5 | 12 | 20 max. [15 typ.] | 18 typ. | 1 | |
| | EZJPZV150RA | 9 | 15 | 20 max. [15 typ.] | 18 typ. | 1 | |
| | EZJPZV270RA | 16 | 27 | 20 max. [15 typ.] | 16.5 typ. | 1 | |
| | EZJPZV270BA | 16 | 27 | 16 | | | |

(1)
A maximum allowable circuit voltage is the upper limit to a circuit voltage. An incorrect maximum allowable circuit voltage leads to grave consequences.

This represents a rising voltage of V-I characteristics, which are the basic characteristics of the varistor.

(2)
When a multilayer varistor is used in a communication circuit, the capacitance affects the signal waveform. Check the capacitance carefully.

This represents the varistor's ability to absorb surge energy, which is defined as the peak of a surge current waveform.

(3)
Specified by standard electrostatic test conditions

The multilayer varistor is selected basically in the same manner as the ZNR surge absorber. Its maximum allowable voltage, surge current withstand, etc., are specified according to the same criteria adopted for the selection of the ZNR surge absorber.

The multilayer varistor is mainly used as a means to protect mobile devices/portable equipment from static electricity, and therefore must be selected with its application to high-speed signal lines and tolerance to static electricity taken into consideration.

(1) Maximum allowable voltage

The source voltage of a circuit in which the varistor is incorporated shall not exceed the maximum allowable circuit voltage. Using the varistor in a circuit with a source voltage higher than the maximum allowable circuit voltage may lead to the deterioration or destruction of the varistor. Care should be taken to avoid such cases.

(2) Capacitance

In a case where the varistor voltage remains the same, the larger the capacitance is, the better the static electricity absorption performance or static-resistance performance becomes. However, when the varistor is used in a signal line, the varistor's larger capacitance affects signal quality. For this reason, a varistor whose capacitance is large but not so large as to affect the signal quality, is selected.

Capacitances to be adopted for major communication lines.
(Capacitances of components other than the varistor are also included.)

- Ethernet, HDMI : 1 pF or less
- USB, IEEE1394 : 3 pF or less
- LIN, CAN etc. : 50 pF or less

(3) Static electricity withstand

Static electricity withstand is specified based on standard electrostatic test conditions defined in public standards.

- IEC61000-4-2 : 150 pF, 330 Ω , 8 kV(Contact discharge) → General commercial products
- ISO10605 : 330 pF, 2 k Ω , 25 kV(Contact discharge) → In-vehicle electrical equipment

8-1. Major product models and their features

| Product type series | Appearance | Feature / Application | | | | | | | | | | | | |
|--|---|---|-------------------|------------------|---|----------------------------|--------------|----------------------------|---------------------------|---------------|-----------------|------------|----------------|-----------|
| ZNR surge absorber D type Disc type / Radial lead type |  | <p>Feature</p> <ul style="list-style-type: none"> •High surge absorption performance utilizing excellent technology in which the Zinc-Oxide Varistor material was developed for the first time in the world. •Product lineup available for use in a wide range of applications including low-voltage circuits and AC power circuits used in various countries around the world. •Widely improved surge absorption performance (E series). <p>Application</p> <p>Protection against surges in various electronic devices for commercial or industrial use.</p> <table border="1"> <thead> <tr> <th>Part No. · Series</th> <th>Varistor voltage</th> <th>Maximum peak current (8/20 μs1time)</th> </tr> </thead> <tbody> <tr> <td>ERZV□□D□□□□ (V series)</td> <td>18 to 1800 V</td> <td>250 to 10000 A</td> </tr> <tr> <td>ERZE□□A□□□□ (E series)</td> <td>200 to 1100 V</td> <td>1200 to 10000 A</td> </tr> </tbody> </table> | Part No. · Series | Varistor voltage | Maximum peak current (8/20 μs1time) | ERZV□□D□□□□ (V series) | 18 to 1800 V | 250 to 10000 A | ERZE□□A□□□□ (E series) | 200 to 1100 V | 1200 to 10000 A | | | |
| Part No. · Series | Varistor voltage | Maximum peak current (8/20 μs1time) | | | | | | | | | | | | |
| ERZV□□D□□□□ (V series) | 18 to 1800 V | 250 to 10000 A | | | | | | | | | | | | |
| ERZE□□A□□□□ (E series) | 200 to 1100 V | 1200 to 10000 A | | | | | | | | | | | | |
| ZNR surge absorber SMD type VF series Surface-mounted type |  | <p>Feature</p> <ul style="list-style-type: none"> •Resin-molded surface-mounted product •Mounted by reflow/flow soldering •Small in size and low height (6.0×8.0×3.2 mm) <p>Application</p> <p>Protection against surges in circuits required to be small and thin, such as circuits making up BS tuners, notebook PCs, switching power supplies, game machines, etc.</p> <table border="1"> <thead> <tr> <th>Part No. · Series</th> <th>Varistor voltage</th> <th>Surge current withstand (8/20 μs2 times)</th> </tr> </thead> <tbody> <tr> <td>ERZVF□M□□□□ (VF series)</td> <td>22 to 470 V</td> <td>125 to 600 A</td> </tr> </tbody> </table> | Part No. · Series | Varistor voltage | Surge current withstand (8/20 μs2 times) | ERZVF□M□□□□ (VF series) | 22 to 470 V | 125 to 600 A | | | | | | |
| Part No. · Series | Varistor voltage | Surge current withstand (8/20 μs2 times) | | | | | | | | | | | | |
| ERZVF□M□□□□ (VF series) | 22 to 470 V | 125 to 600 A | | | | | | | | | | | | |
| For automotive ZNR surge absorber SMD type HF series Surface-mounted type |  | <p>Feature</p> <ul style="list-style-type: none"> •Protection against surges in various types of in-vehicle equipment as specified in JASO A-1, ISO7637-2, ISO16750-2, etc. <p>Application</p> <p>Various types of in-vehicle ECUs</p> <table border="1"> <thead> <tr> <th>Part No.</th> <th>Varistor voltage</th> <th>Maximum allowable voltage Short time overvoltage</th> <th>Clamping voltage</th> </tr> </thead> <tbody> <tr> <td>ERZVF2M220D</td> <td>22 to 23.2 V</td> <td>DC 16 V</td> <td>35 V(max)</td> </tr> <tr> <td>ERZVF2M270</td> <td>27 V ± 20%</td> <td>DC 24 V 5 min.</td> <td>43 V(max)</td> </tr> </tbody> </table> | Part No. | Varistor voltage | Maximum allowable voltage Short time overvoltage | Clamping voltage | ERZVF2M220D | 22 to 23.2 V | DC 16 V | 35 V(max) | ERZVF2M270 | 27 V ± 20% | DC 24 V 5 min. | 43 V(max) |
| Part No. | Varistor voltage | Maximum allowable voltage Short time overvoltage | Clamping voltage | | | | | | | | | | | |
| ERZVF2M220D | 22 to 23.2 V | DC 16 V | 35 V(max) | | | | | | | | | | | |
| ERZVF2M270 | 27 V ± 20% | DC 24 V 5 min. | 43 V(max) | | | | | | | | | | | |
| ZNR surge absorber SC type Conforming to JIS |  | <p>Feature</p> <ul style="list-style-type: none"> •Best choice as an absorber incorporated in surge protection devices conforming to JIS C5381-11/IEC 61643-11 •Compact in size and yet offers a large surge current withstand •An electric terminal and a fixing terminal that are combined together <p>Application</p> <p>Protection against surges in industrial equipment, power supplies for communication devices, power supplies for radio relay stations, distribution boards in power stations/substations, control boards, etc.</p> <table border="1"> <thead> <tr> <th>Part No.</th> <th>Varistor voltage</th> <th>Nominal discharge current In (8/20 μs) Maximum discharge current max (8/20 μs)</th> </tr> </thead> <tbody> <tr> <td>ERZVS34C□□□□</td> <td>200 to 950 V</td> <td>In : 20 kA Imax : 40 kA</td> </tr> </tbody> </table> | Part No. | Varistor voltage | Nominal discharge current In (8/20 μs) Maximum discharge current max (8/20 μs) | ERZVS34C□□□□ | 200 to 950 V | In : 20 kA Imax : 40 kA | | | | | | |
| Part No. | Varistor voltage | Nominal discharge current In (8/20 μs) Maximum discharge current max (8/20 μs) | | | | | | | | | | | | |
| ERZVS34C□□□□ | 200 to 950 V | In : 20 kA Imax : 40 kA | | | | | | | | | | | | |

| Product type series | Appearance | Feature / Application | | | | | | | | | |
|---|---|--|----------|------------------|--|--|---------------|---------------------|---|---------------|----------------------|
| ZNR surge absorber E type Case type |  | <p>Feature</p> <ul style="list-style-type: none"> •Having a large ZNR element of ϕ 20 or ϕ 32 and sealed in a resin case •Compact in size and yet offers a large surge current withstand •Can be attached directly to a distribution board, etc. <p>Application</p> <p>Protection against surges in railway signal devices, devices in broadcasting relay stations, communication/control devices, power distribution controllers, etc.</p> <table border="1"> <thead> <tr> <th>Part No.</th> <th>Varistor voltage</th> <th>Maximum peak current (8/20 μs1time)</th> </tr> </thead> <tbody> <tr> <td>ERZC20EK□□□□</td> <td>200 to 1100 V</td> <td>8000 A</td> </tr> <tr> <td>ERZC32EK□□□□</td> <td>200 to 1100 V</td> <td>25000 A</td> </tr> </tbody> </table> | Part No. | Varistor voltage | Maximum peak current (8/20 μ s1time) | ERZC20EK□□□□ | 200 to 1100 V | 8000 A | ERZC32EK□□□□ | 200 to 1100 V | 25000 A |
| Part No. | Varistor voltage | Maximum peak current (8/20 μ s1time) | | | | | | | | | |
| ERZC20EK□□□□ | 200 to 1100 V | 8000 A | | | | | | | | | |
| ERZC32EK□□□□ | 200 to 1100 V | 25000 A | | | | | | | | | |
| ZNR surge absorber CK type Tab terminal structure |  | <p>Feature</p> <ul style="list-style-type: none"> •Having a large ZNR element of ϕ 32 or ϕ 40 and tab terminals coated with resin •An electric terminal and a fixing terminal that are combined together •Compact in size and yet offering a large surge current withstand <p>Application</p> <p>Protection against surges in industrial electronic devices, power supplies for communication devices, etc.</p> <table border="1"> <thead> <tr> <th>Part No.</th> <th>Varistor voltage</th> <th>Maximum peak current (8/20 μs1time)</th> </tr> </thead> <tbody> <tr> <td>ERZC32CK□□□□</td> <td>200 to 950 V</td> <td>25000 A</td> </tr> <tr> <td>ERZC40CK□□□□</td> <td>200 to 950 V</td> <td>30000 A</td> </tr> </tbody> </table> | Part No. | Varistor voltage | Maximum peak current (8/20 μ s1time) | ERZC32CK□□□□ | 200 to 950 V | 25000 A | ERZC40CK□□□□ | 200 to 950 V | 30000 A |
| Part No. | Varistor voltage | Maximum peak current (8/20 μ s1time) | | | | | | | | | |
| ERZC32CK□□□□ | 200 to 950 V | 25000 A | | | | | | | | | |
| ERZC40CK□□□□ | 200 to 950 V | 30000 A | | | | | | | | | |
| <div style="background-color: #e91e63; color: white; padding: 2px;">For in-vehicle equipment/ general products</div> Multilayer varistors EZJP, EZJZ series Varistor for protection against static electricity/noise |  | <p>Feature</p> <ul style="list-style-type: none"> •A rich lineup of varistors with various laminated structures can be used in a wide range of applications including power supplies and signal circuits. •EIA size 0201, 0402, 0603 (inch) <p>Application</p> <p>Protection against ESD/noise in mobile phones, various interfaces, etc.</p> <table border="1"> <thead> <tr> <th>Part No.</th> <th>Varistor voltage</th> <th>Capacitance (at 1 MHz)</th> </tr> </thead> <tbody> <tr> <td>EZJZ□□V□□□□□□□□ For High speed signal lines</td> <td>80 to 170 V</td> <td>0.8 to 2.1 pF typ</td> </tr> <tr> <td>EZJ□□□V□□□□□□□□ For DC voltage lines</td> <td>6.8 to 65 V</td> <td>8.5 to 420 pF typ</td> </tr> </tbody> </table> | Part No. | Varistor voltage | Capacitance (at 1 MHz) | EZJZ□□V□□□□□□□□ For High speed signal lines | 80 to 170 V | 0.8 to 2.1 pF typ | EZJ□□□V□□□□□□□□ For DC voltage lines | 6.8 to 65 V | 8.5 to 420 pF typ |
| Part No. | Varistor voltage | Capacitance (at 1 MHz) | | | | | | | | | |
| EZJZ□□V□□□□□□□□ For High speed signal lines | 80 to 170 V | 0.8 to 2.1 pF typ | | | | | | | | | |
| EZJ□□□V□□□□□□□□ For DC voltage lines | 6.8 to 65 V | 8.5 to 420 pF typ | | | | | | | | | |
| Multilayer varistors EZJS series Varistor for protection against static electricity/noise (High capacitance type) |  | <p>Feature</p> <ul style="list-style-type: none"> •Its combined varistor/capacitor functions achieved by the original varistor material technology offer excellent static electricity suppression effects. •EIA size 0603, 0805 (inch) <p>Application</p> <p>Protection against ESD/noise in power supplies, SSRs, motors, etc.</p> <table border="1"> <thead> <tr> <th>Part No.</th> <th>Varistor voltage</th> <th>Capacitance (at 1 MHz)</th> </tr> </thead> <tbody> <tr> <td>EZJS1□□□□□□□□ 1608 type</td> <td>12 to 50 V</td> <td>1800 to 8200 pF typ</td> </tr> <tr> <td>EZJS2□□□□□□□□ 2012 type</td> <td>12 to 50 V</td> <td>4700 to 22000 pF typ</td> </tr> </tbody> </table> | Part No. | Varistor voltage | Capacitance (at 1 MHz) | EZJS1□□□□□□□□ 1608 type | 12 to 50 V | 1800 to 8200 pF typ | EZJS2□□□□□□□□ 2012 type | 12 to 50 V | 4700 to 22000 pF typ |
| Part No. | Varistor voltage | Capacitance (at 1 MHz) | | | | | | | | | |
| EZJS1□□□□□□□□ 1608 type | 12 to 50 V | 1800 to 8200 pF typ | | | | | | | | | |
| EZJS2□□□□□□□□ 2012 type | 12 to 50 V | 4700 to 22000 pF typ | | | | | | | | | |

8-2. Part number notation on major products

The product number of a ZNR varistor includes 12 places maximum.

The product number is made up of a common symbol, which is "ERZ" for ZNRs and "EZJZ," "EZJP," and "EZJS" for chip laminated varistors, a shape symbol, a varistor voltage, and a capacitance (see the catalog for detailed information).

[D type V series, E series]

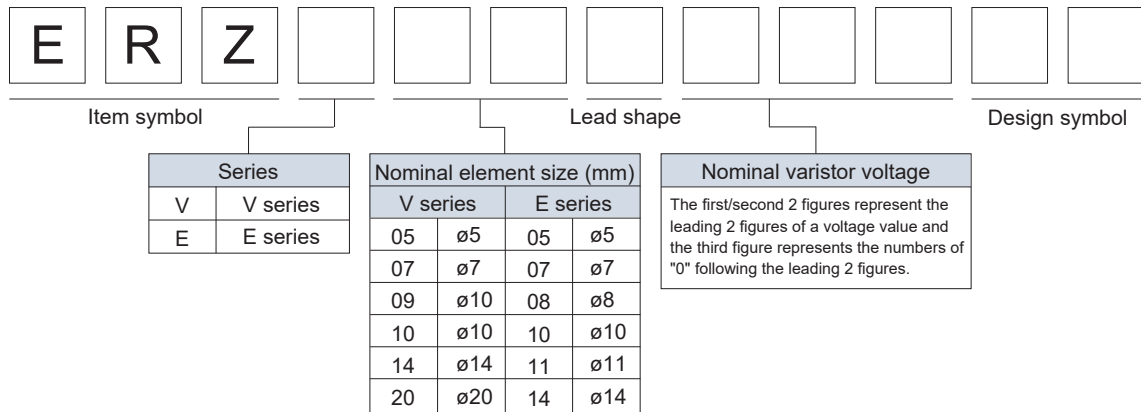

[SMD type VF series]

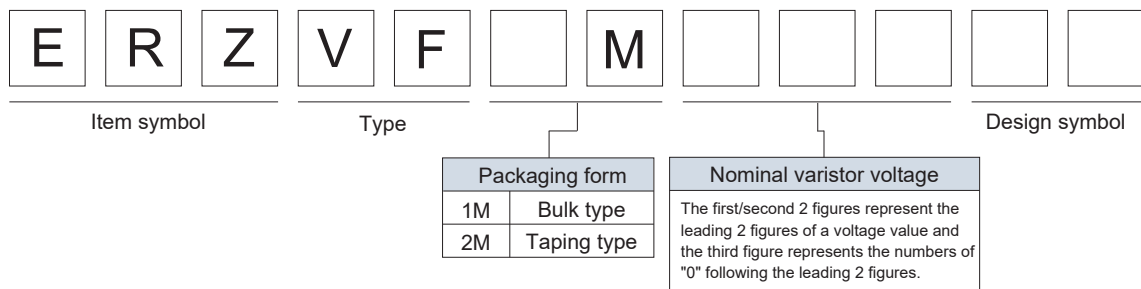

[Chip laminated varistors (EZJP, EZJZ series)]

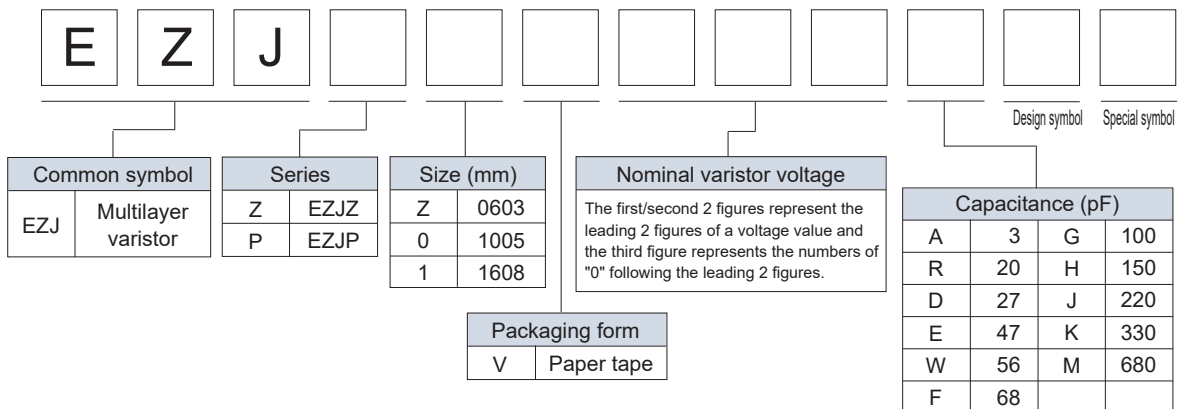

[Chip laminated varistors (EZJS series)]

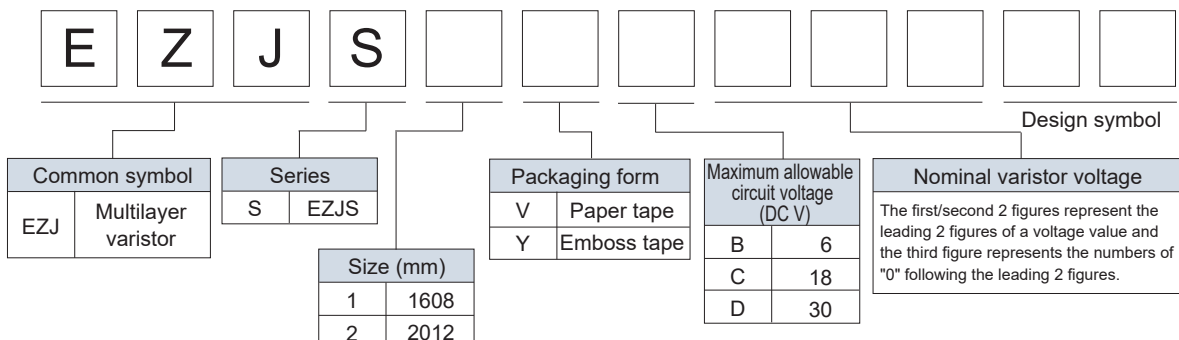

Examples of selecting/using a ZNR for individual cases where surge voltages are generated by different causes.
 The ZNR to be used is examined with Safety precautions / Application notes in catalogs/specifications taken into consideration.

9-1. Power supply line protection against lightning surge

To prevent a surge voltage from intruding into a device through a power line, the ZNR is connected between power lines or between a power line and the ground. Because the varistor voltage of the ZNR varies depending on the source voltage of the circuit, the proper ZNR needs to be selected according to the following table.

Table 9.1 Across-the-line / Line to line protection (Example)

| Examples of ZNR application | Examples of ZNR selection | | | | | | | | | | | | | | | | | | | | | | | |
|---|--|------------|--------------------------|-----|----------------------|-----------|--|------|----------|---------|--------------------------|----------|---------|----------------|---------|------------|--|---------|------------|--|------|----------|---------|----------------|
| <div style="border: 1px solid black; padding: 5px; margin-bottom: 10px;"> DC, AC single-phase <p style="font-size: small;">As countermeasure against surge exceeding the rating of ZNR a fuse is required.</p> <p style="text-align: right; font-size: small;">f: Current fuse</p> </div> <div style="border: 1px solid black; padding: 5px;"> AC Three-phase <p style="font-size: small;">As countermeasure against surge exceeding the rating of ZNR a fuse is required.</p> <p style="text-align: right; font-size: small;">f: Current fuse</p> </div> | <p>Across-the-line / line to line use</p> <table border="1" style="width: 100%; border-collapse: collapse;"> <thead> <tr style="background-color: #d9e1f2;"> <th>ZNR</th> <th>Nominal line voltage</th> <th colspan="2">Part. No.</th> </tr> </thead> <tbody> <tr> <td rowspan="4" style="text-align: center;">ZNR1</td> <td>AC 100 V</td> <td>ERZV□□D</td> <td>201, 221, 241, 271, 361*</td> </tr> <tr> <td>AC 200 V</td> <td>ERZV□□D</td> <td>471, 511, 621*</td> </tr> <tr> <td>DC 12 V</td> <td>ERZV□□D220</td> <td></td> </tr> <tr> <td>DC 24 V</td> <td>ERZV□□D390</td> <td></td> </tr> <tr> <td>ZNR3</td> <td>AC 200 V</td> <td>ERZV□□D</td> <td>471, 511, 621*</td> </tr> </tbody> </table> <p>Notes</p> <ol style="list-style-type: none"> Product numbers listed in the table are examples. Make sure that the source voltage at its peak does not exceed the maximum allowable circuit voltage. When the circuit includes a single-line load or a capacitive load, the source voltage rises temporarily due to resonance caused by switching. It is therefore recommended that ZNRs with product numbers indicated by "*" be used as much as possible for 100 V AC/200 V AC power supplies. When using a ZNR to protect an electronic device for marketing overseas from power surges, please check overseas safety standards before using the ZNR (see catalogs). | | | ZNR | Nominal line voltage | Part. No. | | ZNR1 | AC 100 V | ERZV□□D | 201, 221, 241, 271, 361* | AC 200 V | ERZV□□D | 471, 511, 621* | DC 12 V | ERZV□□D220 | | DC 24 V | ERZV□□D390 | | ZNR3 | AC 200 V | ERZV□□D | 471, 511, 621* |
| ZNR | Nominal line voltage | Part. No. | | | | | | | | | | | | | | | | | | | | | | |
| ZNR1 | AC 100 V | ERZV□□D | 201, 221, 241, 271, 361* | | | | | | | | | | | | | | | | | | | | | |
| | AC 200 V | ERZV□□D | 471, 511, 621* | | | | | | | | | | | | | | | | | | | | | |
| | DC 12 V | ERZV□□D220 | | | | | | | | | | | | | | | | | | | | | | |
| | DC 24 V | ERZV□□D390 | | | | | | | | | | | | | | | | | | | | | | |
| ZNR3 | AC 200 V | ERZV□□D | 471, 511, 621* | | | | | | | | | | | | | | | | | | | | | |

Table 9.2 Line to line and line to ground protection (Example)

| Examples of ZNR application | Examples of ZNR selection | | | | | | | | | | | | | |
|---|--|----------------------------|--|-----|----------------------|-----------|------|----------|-----------------------|----------|----------------------------|------|----------|------------------|
| <div style="border: 1px solid black; padding: 5px; margin-bottom: 10px;"> DC, AC single-phase <p style="font-size: small;">As countermeasure against surge exceeding the rating of ZNR a fuse is required.</p> <p style="text-align: right; font-size: small;">f1: Current fuse f2: Thermal fuse</p> </div> <div style="border: 1px solid black; padding: 5px;"> AC Three-phase <p style="font-size: small;">As countermeasure against surge exceeding the rating of ZNR a fuse is required.</p> <p style="text-align: right; font-size: small;">f1: Current fuse f2: Thermal fuse</p> </div> | <p>Line to ground</p> <table border="1" style="width: 100%; border-collapse: collapse;"> <thead> <tr style="background-color: #d9e1f2;"> <th>ZNR</th> <th>Nominal line voltage</th> <th>Part. No.</th> </tr> </thead> <tbody> <tr> <td rowspan="2" style="text-align: center;">ZNR2</td> <td>AC 100 V</td> <td>ERZV□□D471, 511, 621*</td> </tr> <tr> <td>AC 200 V</td> <td>or ERZV□□D821 and higher**</td> </tr> <tr> <td>ZNR4</td> <td>AC 200 V</td> <td>or ERZV□□D182***</td> </tr> </tbody> </table> <p>Notes</p> <ol style="list-style-type: none"> When an insulation resistance test (500 V mega test) of a device is conducted, a leak current from the ZNR may lead to a misinterpretation of test results as a failure. Remove the ZNR, if approved, or use one of the ZNRs indicated by "*" ." When a withstand voltage test (1000 V AC or 1300 V AC) of a device is conducted, a leak current from the ZNR may lead to a misinterpretation of test results as a failure. Remove the ZNR, if approved, or use one of the ZNRs indicated by "*" ." When using a ZNR to protect an electronic device for marketing overseas from power surges, please check overseas safety standards before using the ZNR (see catalogs). When using the product between the line and the ground, install an earth leakage breaker on the power supply side because the current fuse may not cut due to the ground resistance even if the ZNR is short-circuited. If an earth leakage breaker is not installed, use a thermal fuse in series. | | | ZNR | Nominal line voltage | Part. No. | ZNR2 | AC 100 V | ERZV□□D471, 511, 621* | AC 200 V | or ERZV□□D821 and higher** | ZNR4 | AC 200 V | or ERZV□□D182*** |
| ZNR | Nominal line voltage | Part. No. | | | | | | | | | | | | |
| ZNR2 | AC 100 V | ERZV□□D471, 511, 621* | | | | | | | | | | | | |
| | AC 200 V | or ERZV□□D821 and higher** | | | | | | | | | | | | |
| ZNR4 | AC 200 V | or ERZV□□D182*** | | | | | | | | | | | | |

9-2. Switching surge protection

In a power circuit including an inductive load, such as a transformer, relay, and motor, opening a switch to cut off the power supply generates a large counter electromotive force of the inductive load (see 5-3, page 9).

This counter electromotive force is generated every time the switch is flipped open, that is, generated frequently, and a surge voltage created by the counter electromotive force shows a high peak value, thus possibly causing damage to ICs, transistors, etc., making up electronic devices.

The surge voltage is observed also in the form of a spark from the contact of a switch. Such a surge voltage causes the contact to wear out or fuse, posing another problem.

To absorb such a surge voltage, basically, ZNRs are connected to both ends of an inductive load.

Table 9.3 Switching surge protection (Examples)

| Examples of ZNR application | Examples of ZNR selection | | | | | | | | | | |
|---|---|----------------|-----------|---------|------------|---------|------------|----------|------------|----------|---------------------------|
| <p>(Fig.A)</p> <p>AC power supply</p> <p>Power transformer</p> <p>(Fig.B)</p> <p>DC power supply</p> <p>Relay or solenoid coil</p> | <table border="1" style="width: 100%; border-collapse: collapse;"> <thead> <tr style="background-color: #d9e1f2;"> <th>Source voltage</th> <th>Part. No.</th> </tr> </thead> <tbody> <tr> <td>DC 12 V</td> <td>ERZV□□D220</td> </tr> <tr> <td>DC 24 V</td> <td>ERZV□□D390</td> </tr> <tr> <td>DC 100 V</td> <td>ERZV□□D151</td> </tr> <tr> <td>AC 100 V</td> <td>ERZV□□D221, 241, 271, 361</td> </tr> </tbody> </table> <p>Notes</p> <ol style="list-style-type: none"> 1) When a ZNR is used with a source voltage different from the source voltages listed in the above table, please make sure that the source voltage at its peak does not exceed the maximum allowable voltage. 2) When selecting a surge withstand (or energy withstand or maximum average pulse power), take surge energy generated by the load into full consideration. 3) Pay attention to notes on surge protection measures related to an AC power supply (in the case of Fig. A). | Source voltage | Part. No. | DC 12 V | ERZV□□D220 | DC 24 V | ERZV□□D390 | DC 100 V | ERZV□□D151 | AC 100 V | ERZV□□D221, 241, 271, 361 |
| Source voltage | Part. No. | | | | | | | | | | |
| DC 12 V | ERZV□□D220 | | | | | | | | | | |
| DC 24 V | ERZV□□D390 | | | | | | | | | | |
| DC 100 V | ERZV□□D151 | | | | | | | | | | |
| AC 100 V | ERZV□□D221, 241, 271, 361 | | | | | | | | | | |

9-3. ZNR selection flowchart

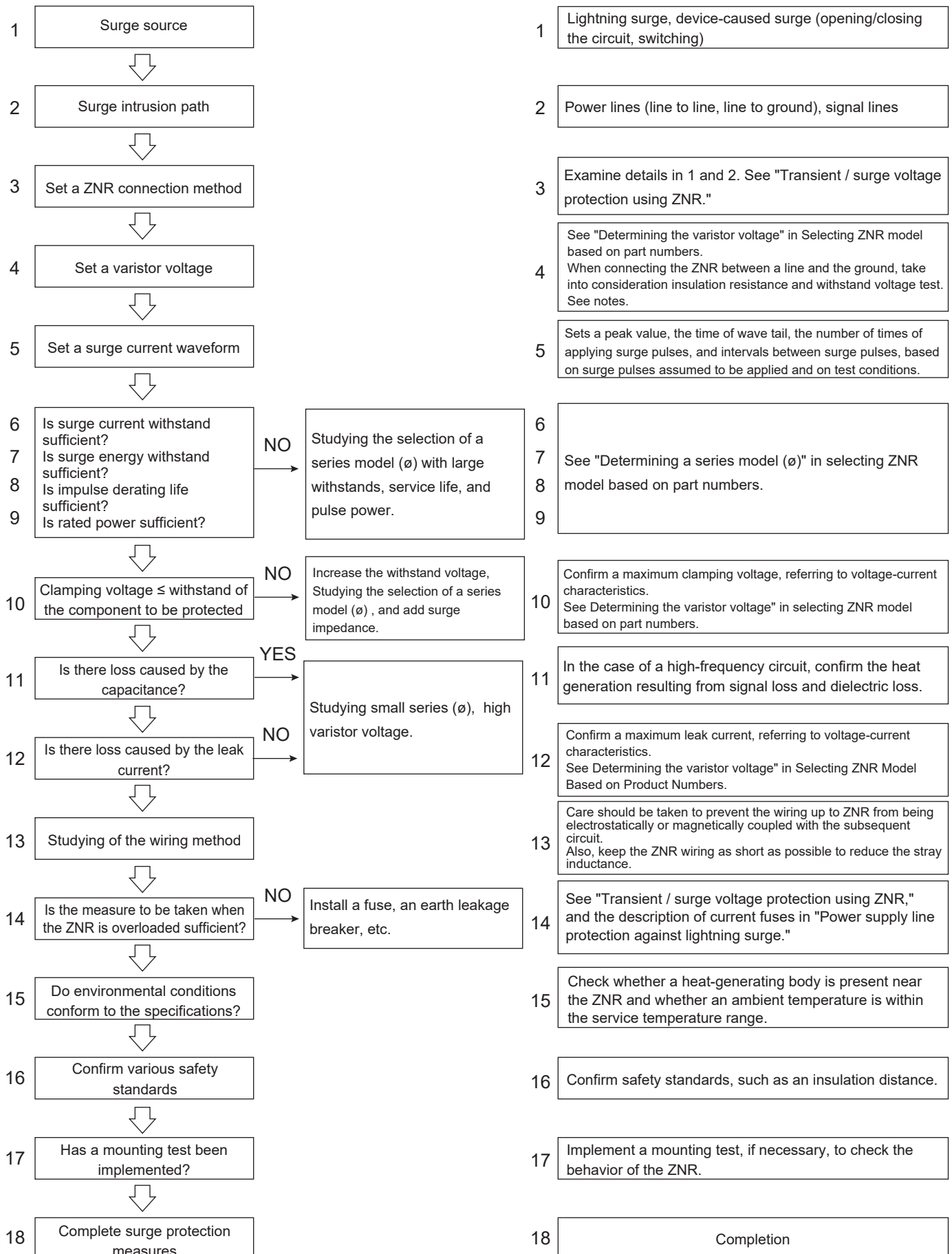

9-4. Typical ZNR selection flowchart

(1) Protective measures against lightning surges in power lines

① Circuit to be protected

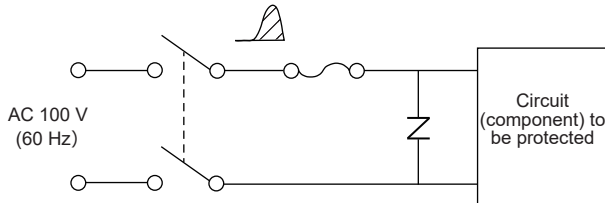

② Circuit/surge conditions

1. Surge voltage : Between lines 10 kV (1.2 / 50 μ s)
2. Number of times of surge application : 10 times / 10 years
3. Surge impedance : 50 Ω
4. Surge withstand voltage of the circuit to be protected : 1000 V

③ Design procedure based on a ZNR selection flowchart

| | | |
|----|--|---|
| 1 | Surge source | Lightning surge |
| 2 | Surge intrusion path | Power line |
| 3 | Set a ZNR connection method | Connect the ZNR between power lines. |
| 4 | Set a varistor voltage | Set 360 V is recommended for a circuit with a circuit voltage of 100 V AC. |
| 5 | Set a surge current waveform | a) Surge current peak value $I = 10,000 \text{ V} / 50 \Omega = 200 \text{ A}$ b) Time of wave tail (Surge current continuing time) A surge current flowing through the ZNR distorts in the waveform, which makes the time of wave tail of the surge current shorter than 50 μ s. As a safety precaution, however, set T=50 μ s. |
| 6 | Surge current withstand | Since the number of times surges are applied is 10 times/year x 10 years = 100 times, the impulse life is considered. |
| 7 | Surge energy withstand | Considering impulse life. |
| 8 | Impulse life | Assumed conditions: surge current peak value=200 A, time of wave tail=50 μ s, number of times of surge application=100 times, surge application interval=5 minutes or longer ERZV series models show their impulse life as follows from Impulse derating. • ERZV07D361 (ϕ 7 series) withstand 10 to 100 times of surge application • ERZV10D361 (ϕ 10 series) withstand 100 to 1000 times of surge application Based on this list, select ERZV10D361. |
| 9 | Rated Power | Given that the number of times of surge application is 100 times and the surge application interval is 5 minutes or longer, considering average pulse power is unnecessary. |
| 10 | Clamping voltage \leq withstand of the component | A relationship between the limit voltage and the withstand voltage is: $V_{200 \text{ A}} \approx 750 \text{ V} < 1000 \text{ V}$, which meets the protective coordination requirement. |
| 11 | Is there loss caused by the capacitance? | Considering capacitance-related loss problems is unnecessary when the ZNR is on a commercial power line supplied with AC 60 Hz. |
| 12 | Is there loss caused by the leak current? | Considering a leak current of a μ A level is unnecessary when the ZNR is on a commercial power line supplied with 100 V AC. |
| 13 | Studying a wiring method | See to it that a circuit element preceding the ZNR is not electrostatically or magnetically connected to a circuit element of a trailing stage and that the wiring structure of the ZNR is made as compact as possible to reduce stray inductance. |
| 14 | Measure to be taken when the ZNR is overloaded | Provide a fuse allowing a current flow of about 5 A with a position closer to the power supply |
| 15 | Environmental conditions | When no heat-generating body is present near the ZNR, check whether the ambient temperature is within a service temperature range. |
| 16 | Safety standards | Confirm safety standards to apply, such as an insulation distance. |
| 17 | Mounting test | Connect the ZNR to the circuit and conduct a check test when necessary. |
| 18 | Connect ERZV10D361 to the circuit, as shown in the figure of (1). Now the protective measure is completed. | |

(2) Protective measures against switching surges from relays

① Circuit to be protected

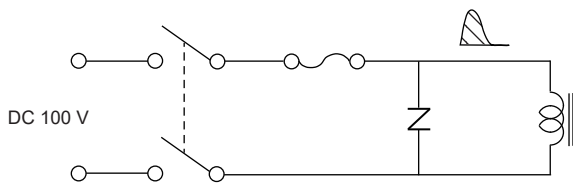

② Circuit/surge conditions

- | | |
|--|--|
| 1. Coil rating | : I=0.3 A, L = 1 H |
| 2. Number of times of the relay' s opening/closing | : 2times / sec. Total 10 ⁸ times |
| 3. Suppression voltage | : 250 V or less |

③ Design procedure based on a ZNR selection flowchart

| | | |
|----|--|--|
| 1 | Surge source | Device-caused surge (switching surge) |
| 2 | Surge intrusion path | A surge that arises between a relay and a coil and propagates through a power line. |
| 3 | Set a ZNR connection method | Connect the ZNR between power lines. |
| 4 | Set a varistor voltage | Assume maximum circuit voltage is 110% of a circuit voltage of 100 V DC, and select a varistor voltage of 150 V where the maximum allowable voltage is 110 V DC or higher. |
| 5 | Set a surge current waveform | Actual observation of a surge current waveform, in addition to the following calculations, allows precise surge current waveform setting. a) Surge current waveform peak value Set the peak value to 0.3 A which is equal to the peak value of the load current. b) Time of wave tail (Surge current continuing time) Consider the surge current to be a square wave current, and determine its time of wave tail using the equations below, where V_i denotes an approximation of a clamping voltage when current I (A) flows through the varistor with a varistor voltage of 150 V. $J = (1/2) \cdot L \cdot I^2 = (1/2) \times 1 \times 0.3^2 = 0.045, \quad V_i \approx 200 \text{ V}$ $T = J / (I \cdot V_i) = 0.045 / (0.3 \times 200) = 7.5 \times 10^{-4} = 0.75 \text{ (ms)}$ |
| 6 | Surge current withstand | The number of times of surge applications is 10 ⁸ times. Surge withstand is determined based on a service life affected by this surge application. |
| 7 | Surge energy withstand | Considering impulse life. |
| 8 | Impulse life | Surge current waveform peak value=0.3 A, time of wave tail=0.75 ms, number of times of surge application=10 ⁸ times, surge application interval=0.5 sec: Because this surge application interval is shorter than the specified surge application interval=10 sec., the equivalent number of times of surge application for the surge application interval being 10 sec. is determined. Equivalent current value=0.3 A×(10 s/0.5 s)=6 A, equivalent number of times of surge application=10 ⁸ ×(0.5 s/10 s)=5×10 ⁶ times ERZV series models show their impulse life as follows from Impulse derating. ERZV07D151 (ø 7 series) withstand 10 ⁴ to 10 ⁵ times of surge application < 5×10 ⁶ times ERZV10D151 (ø 10 series) withstand over 10 ⁶ times of surge application > 5×10 ⁶ times Based on this list, select ERZV10D151. |
| 9 | Rated power | $P = J \cdot f = (1/2) \cdot L \cdot I^2 \cdot f$ f denotes a repetition frequency (times/sec.) $P = (1/2) \times 1 \times 0.3^2 \times 2 = 0.09 \text{ W}$ The rated power of 0.25 W shown by ERZV07D151 (ø 7 series) is acceptable. However, based on impulse life characteristics described in 8, ERZV10D151 (ø 10 series) should be selected. |
| 10 | Clamping voltage ≤ withstand of the component | A relationship between the limit voltage and the withstand voltage is: $V_{0.3 \text{ A}} = 200 \text{ V} < 250 \text{ V}$, which meets performance requirements. |
| 11 | Is there loss caused by the capacitance? | Considering capacitance-related loss problems is unnecessary when the ZNR is on a DC power line. |
| 12 | Is there loss caused by the leak current? | Considering a leak current problem is unnecessary when the ZNR is on a power line. |
| 13 | Studying a wiring method | To reduce induction effects, set the ZNR as close to an exciting coil as possible. |
| 14 | Measure to be taken when the ZNR is overloaded | Provide a fuse allowing a current flow of about 5 A, which is larger than a load current, at a position closer to the power supply than the ZNR. |
| 15 | Environmental conditions | When no heat-generating body is present near the ZNR, check whether the ambient temperature is within a service temperature range. |
| 16 | Safety standards | Confirm safety standards to apply, such as an insulation distance. |
| 17 | Mounting test | Connect the ZNR to the circuit and conduct a check test when necessary. |
| 18 | Connect ERZV10D151 to the circuit, as shown in the figure of (1). Now the protective measure is completed. | |

(3) ZNR selection according to surge test standards

① Circuit to be protected

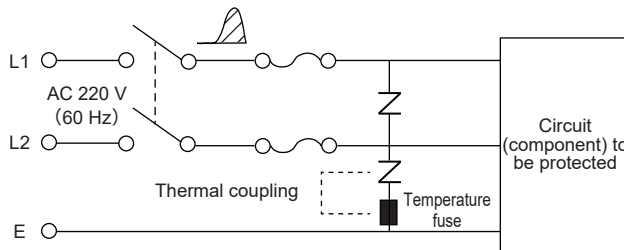

② Circuit/surge conditions

1. Test standards : IEC61000-4-5 Level 3
2. Test conditions : Line to line 1 kV(2Ω), line to ground 2 kV(12Ω)
Apply surge pulses five times each at phase angles of 0, 90, 180, and 270 degrees.
Suppression voltage : Between lines 1500 V, between a line and the ground 5000 V

③ Design procedure based on a ZNR selection flowchart

| | | |
|----|---|---|
| 1 | Surge source | Lightning surge test machine. |
| 2 | Surge intrusion path | Line-to-line and line-to-ground. |
| 3 | Set a ZNR connection method | Connect the ZNR line-to-line and line-to-ground. |
| 4 | Set a varistor voltage | Line-to-line: Set 620 V is recommended for a circuit with a circuit voltage of AC220V. Line-to-ground: Set 1800 V when considering an insulation resistance test (500 V DC) and a withstand voltage test (1000 V AC), in addition to the circuit voltage of AC220 V. |
| 5 | Set a surge current waveform | a) Surge current waveform peak value Line-to-line (L1-L2): Surge application at a phase angle of 90 degrees creates the highest surge voltage. A surge voltage peak value is therefore given as : $220V \text{ AC} \times \sqrt{2} + 1000V \approx 1300V$ When the operation resistance of the ZNR is neglected, the surge current waveform peak value is given as : $1,300V/2 \Omega = 650A$. Actually, however, the ZNR has an operation resistance calculated from its clamping voltage $V_{650} A \approx 1300V$ (in the case of the varistor voltage being 620 V) for 650A, i.e., $1300V/650A = 2 \Omega$. The exact surge current waveform peak value includes this resistance and is therefore given as : $I_p = 1300 V / (2 + 2) \Omega \approx 300A$. Line-to-ground (L2-E): The surge current waveform peak value of a large surge current line to ground (L2-E) is determined in the same manner as the surge current waveform peak value of a surge current line to line. Given $AC220V \times \sqrt{2} + 2000 \approx 2300V$ and $2300V/12\Omega \approx 200A$, the operation resistance is calculated from the clamping voltage $V_{200A} \approx 3200V$ (in the case of the varistor voltage being 1800V) for 200A, being given as $3200V/200 A \approx 16\Omega$. Hence the peak value $I_p = 2300V / (12 + 16)\Omega \approx 80A$. b) Time of wave tail (Surge current continuing time) Line-to-line (L1-L2): The time of wave tail according to the specifications is 20 μs. Under the influence of the operation resistance of the ZNR, however, it turns out to be about 30 μs in actual situations. Line-to-ground (L2-E) : The time of wave tail of a surge current applied between a line and the ground is not specified and is shorter than 50 μs. As a safety precaution, set $T = 50 \mu s$. The time of wave tail may be set by observing the actual waveform, in which case the time of wave tail can be set highly precisely. |
| 6 | Surge current withstand | Surge current withstand is determined based on a impulse life affected by this surge application. |
| 7 | Surge energy withstand | Considering impulse life. |
| 8 | Impulse life | Line-to-line (L1-L2): surge current peak value=300 A, time of wave tail=30 μs, number of times of surge application= 20 times (5 times×4 phase angles), surge application interval=1 minute The impulse derating characteristics graph shows that ERZV10D621 (ø 10 series) withstands $10^2 > 20$ times. ERZV10D621 is thus selected. Line-to-ground (L1-E): surge current peak value=80 A, time of wave tail=50 μs, number of times of surge application= 20 times (5 times×4 phase angles), surge application interval=1 minute Impulse derating characteristics graph shows that ERZV10D182CS (ø 10 series) withstands 10^3 times to 10^4 times of surge application > 20 times. ERZV10D182CS is thus selected. |
| 9 | Rated power | Given that the number of times of surge application is 20 times and the surge application interval is 1 minute, taking into consideration the average pulse power is unnecessary. |
| 10 | Clamping voltage ≤ withstand of the component | Line-to-line (L1-L2): $V_{300A} \approx 1250 V < 1500 V$ Line-to-ground (L1-E): Consider L1-E where the clamping voltage is high, line to ground. The clamping voltage for ZNR at 200 A is 1200V (620V varistor voltage) + 3200V (1800V varistor voltage). Hence $(1200V + 3200V)/200A = 22\Omega$, the peak value $I_p = 2,300 V / (12 + 22) \Omega \approx 68A$. Now clamping voltage at 68A, $V_{68A} \approx 1100V$ (varistor voltage is 620 V) + $V_{68A} \approx 3100V$ (varistor voltage is 1800V) = $4200V < 5000 V$, which meets the protective coordination requirements. |
| 11 | Is there loss caused by the capacitance? | Considering capacitance-related loss problems is unnecessary when the ZNR is on a AC power line. |
| 12 | Is there loss caused by the leak current? | Considering a leak current problem is unnecessary when the ZNR is on a power line. |
| 13 | Studying a wiring method | To reduce induction effects, set the ZNR as close to an exciting coil as possible. |
| 14 | Measure to be taken when the ZNR is overloaded | Provide a fuse allowing a current flow about to 5 A with a position closer to the power supply than the ZNR. Install a thermal fuse line to ground. |
| 15 | Environmental conditions | When no heat-generating body is present near the ZNR, check whether the ambient temperature is within a service temperature range. |
| 16 | Safety standards | Confirm safety standards to apply, such as an insulation distance. |
| 17 | Mounting test | Conduct a surge test of the ZNR to see if the ZNR malfunctions or breaks when exposed to a surge. |
| 18 | Connect ERZV10D621 between lines and RZV10D182CS between a line and the ground, as shown in the figure of (1). Now the protective measure is completed. | |

Safety Precautions

When using our products, no matter what sort of equipment they might be used for, be sure to confirm the applications and environmental conditions with our specifications in advance.

Panasonic

INDUSTRY

“ZNR” Surge Absorbers/Chip laminated varistors
Technical guide

First edition : November 1, 2022

Panasonic Industry Co., Ltd.
Device Solutions Business Division

1006 Kadoma, Kadoma City, Osaka
571-8506 Japan